

The CAT

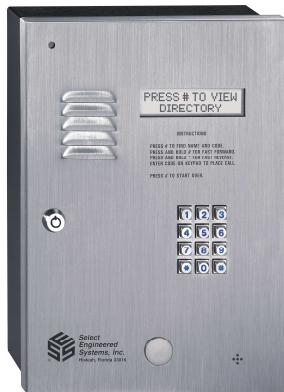

CAT 2

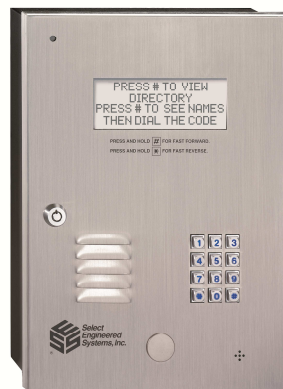

CAT 4

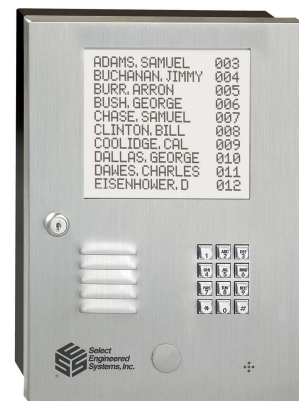

CAT 10



CAT CARD

600CATMANUAL
Sept. 2014



**Select
Engineered
Systems, Inc.**

1	INTRODUCTION CAT SERIES	1
	STANDARD FEATURES	1
	CUSTOMIZING FEATURES	2
	OPTIONS	3
	ENVIRONMENT CONSIDERATIONS	4
	ELECTRICAL REQUIREMENTS	4
	TECHNICAL DATA	4
2	INSTALLATION	5
	GENERAL	5
	WIRE SPECIFICATIONS	5
	TERMINAL WIRING HOOKUP CONNECTIONS	6
	TERMINAL BARRIER STRIP CONNECTION DESCRIPTION	7
	DIP SWITCH SETTINGS	8
	SPEAKER SETTINGS	8
	MICROPHONE SETTINGS	8
	POWER SWITCH	9
3	ACCESSORY INSTALLATION	10
	GENERAL	10
	AVAILABLE OPTIONS	10
	TWO (2) INPUT WIEGAND INPUT MODULE - VOLTAGE SELECT	11
	FOUR (4) INPUT WIEGAND INPUT MODULE - VOLTAGE SELECT	11
	WIRE SPECIFICATIONS	12
	CARD READER WIRING	13
	CARD READER SETTINGS	13
	WIEGAND FORMAT	13
	EXTERNAL WIEGAND INPUT MODULES - RS485 WIRING	14
	K2 RELAY FOR ENTRANCE 3 AND 4	15
	K3 RELAY	16
	ALARM AND CAMERA	16
	TAMPER INPUTS	16
	SHUNT USE FOR 4 WIEGAND INPUT MODULES	16
	SERIAL PORT	17
	PRINTER CONNECTION	17
	MESSAGES	18
	COMPUTER CONNECTION	18
	TERMINAL CONNECTIONS	19
	CURRENT LOOP WIRING	20
	MODEM INSTALLATION	21
	BOARD PLACEMENT	21
	CONNECTIONS	21
	SOFTWARE CONSIDERATIONS	21
	NIC - NETWORK INTERFACE CARD	21
	MULTIPLE UNIT INTERFACE (MUI)	23
	BOARD PLACEMENT	23
	TWO MINUTE LOCKOUT	23

CAT Series v 4.1X

4	PROGRAMMING	25
	QUICK KEYPAD EXAMPLE	25
	TOUCH TONE	26
	INITIALIZATION	27
	MANAGER PASSCODE	28
	PROGRAMMING CHOICES	28
	PROGRAMMING CHOICES	29
	CODES / NAMES	30
	ADD / FIND NAME	30
	DELETING A CODE	30
	DELETING A CODE FIELD	30
	CODES USED	32
	SHOW ALL CODES	32
	SHOW ALL NAMES	32
	ENABLE ACCESS GROUPS	32
	ENTRY CONTROL	32
	ENTRANCE XX UNLOCK TIME	32
	ENTRANCE XX UNLOCK TONE	33
	ENTRANCE XX AUTO GROUP	33
	ENTRANCE XX LATCH TONE	33
	ENTRANCE XX SPECIAL RELAY ENABLE	33
	ENTRANCE XX OPEN DURING PROGRAMMING MODE	33
	SYSTEM PARAMETERS	34
	TALK TIME	34
	ALARM TIME	34
	CODE LENGTH	34
	PIN LENGTH	34
	BACK BEEP	34
	TONE DIAL	35
	UNIT ID. OR RING COUNT	35
	STRIKE OUTS	35
	TITLE PAGE	35 - 36
	COMMUNICATIONS SETUP	36
	TERMINAL TYPE	36
	RS 232 BAUD	37
	PROGRAM PASSWORD	37
	CONTROL PASSWORD	37
	PIN ON ENTRANCE	37
	SITE CODE	37
	DIRECTORY ON / OFF	38
	KEYPAD ON / OFF	38
	SPEAKER TONE	38

PROGRAMMING continued	
CLOCK SETUP	38
SETTING TIME/DATE	38
SETTING TIME ZONES	39
SETTING HOLIDAYS	41
ACCESS LEVELS	42
SELECTING AN ACCESS GROUP	43
SELECTING AN ACCESS LEVEL	43
PROGRAMMING AN ACCESS LEVEL - TABLE	44
AUTOMATIC UNLOCK AND RELOCK BY TIME ZONE	44
EXAMPLE OF AN AUTOMATIC UNLOCK APPLICATION	45 - 46
TRANSACTION BUFFER INFORMATION	45 - 46
VIEW LOG	46
SEND LOG	46
BUFFER FREE	46
CLEAR BUFFER	46
CLEAR DATA	46
SET PARAMETERS	46
CLEAR TIME ZONES	46
CLEAR HOLIDAYS	46
CLEAR ACCESS LEVELS	47
CLEAR ACCESS GROUPS	47
CLEAR CORRUPT DATA	47
DISPLAY DATA	47
SHOW INFO	47
SHOW HOLIDAYS	48
SHOW ACCESS LEVELS	48
SHOW ACCESS GROUPS	48
DISPLAY TIME ZONE	49
DISPLAY HOLIDAYS	49
DISPLAY ACCESS LEVELS	49
DISPLAY ACCESS GROUPS	49
5 TERMINAL PROGRAMMING	50
GENERAL	50
MANAGER PASSCODE	51
PROGRAMMING CHOICES	51—52
CODES / NAMES	53
ADD / FIND NAME	53
DELETING A CODE	53
DELETING A CODE FIELD	53
CODES USED	54
SHOW ALL CODES	54
SHOW ALL NAMES	54
ENABLE ACCESS GROUPS	55
ENTRY CONTROL	55

CAT Series v 4.1X

TERMINAL PROGRAMMING continued

ENTRANCE XX UNLOCK TIME	55
ENTRANCE XX UNLOCK TONE	55
ENTRANCE XX AUTO GROUP	55
ENTRANCE XX LATCH TONE	56
ENTRANCE XX SPECIAL RELAY ENABLE	56
ENTRANCE XX OPEN DURING PROGRAMMING MODE	56
SYSTEM PARAMETERS	57
TALK TIME	57
ALARM TIME	57
CODE LENGTH	57
PIN LENGTH	57
BACK BEEP	57
TONE DIAL	57
UNIT ID. OR RING COUNT	58
STRIKE OUTS	58
TITLE PAGE	58
COMMUNICATIONS SETUP	59
TERMINAL TYPE	59
RS 232 BAUD	59
PROGRAM PASSWORD	59
CONTROL PASSWORD	59
PIN ON ENTRANCE	59
SITE CODE	60
DIRECTORY ON / OFF	60
KEYPAD ON / OFF	60
SPEAKER TONE	60
CLOCK SETUP	60
SETTING TIME/DATE	60
SETTING TIME ZONES	61
SETTING HOLIDAYS	62
ACCESS LEVELS	63
SELECTING AN ACCESS GROUP	64
SELECTING AN ACCESS LEVEL	64
PROGRAMMING AN ACCESS LEVEL - TABLE	64
AUTOMATIC UNLOCK AND RELOCK BY TIME ZONE	65
EXAMPLE OF AN AUTOMATIC UNLOCK APPLICATION	65 - 66
TRANSACTION BUFFER INFORMATION	66
VIEW LOG	66
SEND LOG	66
BUFFER FREE	67
CLEAR BUFFER	67
CLEAR DATA	67

TERMINAL PROGRAMMING continued

SET PARAMETERS	67
CLEAR TIME ZONES	67
CLEAR HOLIDAYS	67
CLEAR ACCESS LEVELS	67
CLEAR ACCESS GROUPS	67
CLEAR CORRUPT DATA	67
DISPLAY DATA	68
SHOW INFO	68
SHOW TIMEZONES	68
SHOW HOLIDAYS	68
SHOW ACCESS LEVELS	68
SHOW ACCESS GROUPS	68
SHOW ENTRANCES	68
SHOW ENTRANCES BY GROUP	68
SHOW LATCH STATE	68
SHOW MODULE STATE	68

CAT Series v 4.1X

1 INTRODUCTION to the CAT SERIES

The CATHF/30, through CATHF/2700, are automatic call , entry and card reader control systems. The CAT Card is a card reader controls system only.



CAT 4 CAT 2

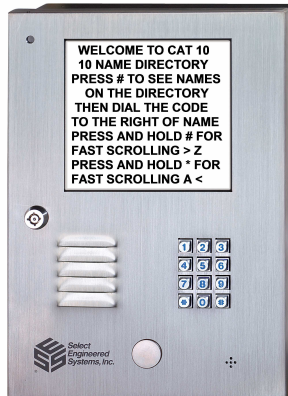

CAT 10

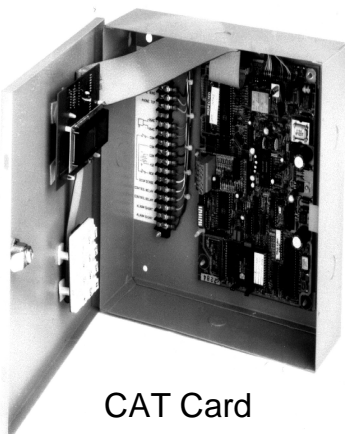

CAT Card

The CAT units operate and program identically. In this manual, the term "CAT" will be used interchangeably to refer to any type of unit. The CAT series line includes a 2 line display LCD display called the CAT2, a 4 line LCD display called the CAT4, and a 10-line display called the CAT-10. There is also the CAT Card which is a card reader system. Except for the display size or housing, the electronics are identical. This programming manual is valid for any model CAT system. Where there are differences, a table will show those differences like this:

The CAT 2 display message is:

**PRESS # TO VIEW
DIRECTORY**

The CAT 4 display message is:

**PRESS # TO VIEW
DIRECTORY
PRESS # TO SEE NAMES
THEN DIAL THE CODE**

The CAT 10 display message is:

**PRESS # TO VIEW
DIRECTORY
PRESS # TO SEE NAMES
ON THE DIRECTORY
THEN DIAL THE CODE
TO THE RIGHT OF NAME
PRESS AND HOLD # FOR
FAST SCROLLING > Z
PRESS AND HOLD * FOR
FAST SCROLLING A <**

STANDARD FEATURES:

- Memory Capacities:
30/50/75/100/150/250/500/750/1000/2000/2700 for residents telephone numbers and names in directory.
- Dials out either Touch-Tone™ or rotary - field programmable.
- Dials up to 14 digit phone numbers.
- Unit will mute tones in speaker during dialing.
- Unit will not accept Touch-Tone™ signals through the microphone.
- Two line 16 character per line LCD display. (CAT 2 Series) Displays one name.
- Four line 20 character per line LCD display. (CAT 4 Series) Displays 4 names.
- Ten line 20 character per line LCD display. (CAT-10 Series) Displays 10 names.
- Programmable without opening cabinet, via keypad, RS-232, NIC2, or Modem with Selcom Software
- 56.6K Baud modem standard
- Talk time field programmable from 1 - 99 min.
- Postal lock capability included.
- Request to exit input for all entrance control relays.
- Entry code attempts (strike out) programmable from 0 - 9.
- Non-volatile memory, retains data even when power is removed.
- Surface or semi-flush mounting.
- Remote Entrance relay activation.
- Latching Entrance relays (with Remote Control Password).
- Programmable background "beep" to indicate call placed from telephone entry unit.
- Personal Identification Number (PIN code). Extra PIN codes above unit capacity.
- Remote Touch-Tone™ Entrance Relay Control.
- Manager Password (First three digits of Program Password).
- Battery charging circuitry.

STANDARD CUSTOMIZING FEATURES

- 1 - 6 digit directory codes field programmable.
 - 0 - 6 digit entry codes Personal Identification Number (PIN) field programmable.
 - Up to 6 cards per Directory code.
 - Up to 16,200 cards may be used
 - Card reader control module for either 2 or 4 entrances using these technologies:
 - 1.) Wiegand, swipe, insert, or keypad.
 - 2.) Proximity, RF Transmitter, Bar Code (Wiegand code only), Long Range Proximity.
 - Transaction Buffer (up to 13,000 transactions depending on code size and options).
 - Clock & Calendar, timed lock and unlock.
 - Time Zones, Access Levels, and Holidays.
- Resident activated door/gate release via Touch-Tone™ number (1-9), field programmable on all entrances.
- Voice mail response capability. (Keypad active after unit calls out, programmed from CAT).
 - Crystal controlled tone detection for short burst 50 MS tone.
 - Speaker Listen-in.

CAT Series v 4.1X

STANDARD CUSTOMIZING FEATURES continued

- Hide Name Feature. Allows people to dial a code without displaying name on directory.
- Two minute modem lockout time.
- Dynamic scrolling, based on number of phone numbers programmed (See table below).
(Scrolls after key is held more than 4 seconds).

Dynamic Scrolling Table

CAT 2	CAT 4	CAT 10
1 to 32 Names scrolls by 2's	scrolls by 4's	scrolls by 8's
33 to 100 Names scrolls by 5's	scrolls by 8's	scrolls by 16's
101 to 260 Names scrolls by 10's	scrolls by 16's	scrolls by 32's
261 or more Names scrolls by 15's	scrolls by 48's	scrolls by 96's

OPTIONS:

- Printer capability (RS-232 port) , Current Loop or NIC2 Interface to printer, terminal or computer
- (Baud rates to printer and/or remote terminal (CRT) 300, 600, 1200, 2400, 4800, 9600, 19200
- Current loop 300, 600, 1200, 2400, 4800, 9600 to 2000 feet.
- Third signal relay with two modes of operation:
 - 1.) for CCTV activation, alarm output, tamper input.
 - 2.) or for control of a third door (timed and latched functions).
- Multiple CAT's (2 - 8 depending on programming mode) can share same telephone line, via multiple unit interfaces (OPTKMUI).
- Local ringer capability.
- Standby batteries.

BASIC OPERATION: The CAT is a microprocessor based device that allows entering from 1 - 6 digits on the front keypad. It then automatically dials the phone number programmed into memory. The CAT provides a relay output for controlling doors, gates, elevators or any device actuated by a contact closure or contact opening. The CAT has a programmable 1 to 99 minute talk-time limit. It provides warning tones near the end of talk time.

The CAT will dial out either pulse (rotary) or Touch-Tone™ via programming selection. While the CAT dials, the speaker disconnects, keeping the dialed phone number confidential.

The CAT has an (optional) relay (OPTK3R). This can (depending on the options ordered and the programming) be configured as either: a third door control, an alarm and off-hook control relay, or Door 1 & 2 shunt relay and door sense. Calling the CAT from a Touch-Tone™ telephone will allow the user to control the output relays by pressing a Touch-Tone™ number. (Factory default is 6 to actuate relay 1.) When the user calls the CAT, the CAT will ring, go off hook and send a ¼ second tone. Entering the proper control password will allow access to the output relays. This also allows relay latching functions.

The (Optional) 12 volt DC .8 A/hr internal battery (B12V) is recommended for line stability. The battery is NOT required for memory storage. SES supplies the CAT with a 16.5 vac transformer that will operate the CAT and recharge the optional internal battery.

DO NOT CONNECT ANY OTHER DEVICES TO THE BATTERY.

ENVIRONMENTAL CONSIDERATIONS

Indoor or Outdoor: The standard CAT housing is suitable for indoor or outdoor installations. For semi-flush installations, contact SES about the optional flush ring (OPTFLR). For surface mount installations, contact SES for the optional trim ring (OPTSL-2). Optional pedestal mounts for curb (PST236), or street (PST242).

ELECTRICAL REQUIREMENTS

Power: The CAT uses 16.5 volt ac 50/60 Hz. SES supplies a 16.5 vac transformer with each purchase in the U.S. only. The installer may choose to provide their own 12 volt 300 - 600 ma. DC supply (for CAT only depending on model type, will not also power card readers). **YOU CAN NOT USE AC TRANSFORMER AND DC SUPPLY AT THE SAME TIME.**

Ground: The CAT must be connected to a good earth ground with at least # 16 ga. stranded wire. This wire **MUST** be a minimum of 16 ga. connected to a ground rod or cold water pipe at one end, and to the provided ¼ -20 bolt at the CAT end. The maximum wire length is 50 feet. Surge damage protection built into CAT diminishes if you do not provide an adequate earth ground.

Relay capabilities: 24 volts AC or DC at 3 amp. Form "C" (N/O) AND (N/C) contacts are present for all relays.

Gate controllers: Some solid-state gate controllers react to the over-voltage protection devices used on all SES products. This is a gate controller dependent problem. The symptom is an intermittent gate open, or gate stuck open condition, sometimes occurring after using the latching function. If this occurs, add an external relay controlled by the CAT output relay contacts to your gate system (OPTKFRMC) . This will help isolate the contacts going to your solid state gate controller from the over-voltage protection devices.

Pedestal Mounting: For installations where the CAT will be mounted on a pedestal, a ground rod **MUST** be installed immediately adjacent to the CAT. In addition, a ground wire of at least # 14 gauge wire must be used from the ¼-20 ground lug mounted in the back of the CAT back-box to the ground rod clamp. This ground wire is to be no more than 25 feet in length, and should have no sharp bends in the wiring.

TECHNICAL DATA

- POWER INPUT: 16.5 VAC 20 VA UL LISTED TRANSFORMER (PROVIDED).
- EMERGENCY BATTERY: 12V .8 A/HR GEL CELL ON CONSTANT CHARGE (OPTIONAL).
- TELEPHONE LINE: VOICE GRADE RJ-11C JACK.
- SHIPPING WEIGHT: APPROXIMATELY 15 LBS.
- CONSTRUCTION: FRONT PANEL: 16 GA. STAINLESS STEEL
- BACK BOX: PAINTED CHEMICALLY TREATED ALLOY ALUMINUM.
- OPERATING ENVIRONMENT: TEMPERATURE: -20° F (-6°C) TO +160°F (70°C)
- RELATIVE HUMIDITY: 5% - 95% NON-CONDENSING.
- RELAY OUTPUT: FORM C DRY CONTACTS 24V @ 3 AMP.
- MOUNTING: SURFACE OR SEMI-FLUSH.
- MEMORY TYPE: NON-VOLATILE.
- TONE DETECTION: CRYSTAL CONTROLLED, WILL DETECT SHORT BURST 50 MILLISECOND TONE.

2 INSTALLATION INSTRUCTIONS
WIRING HOOKUP CONNECTIONS

CAT Series v 4.1X

TBS = TERMINAL BARRIER STRIP

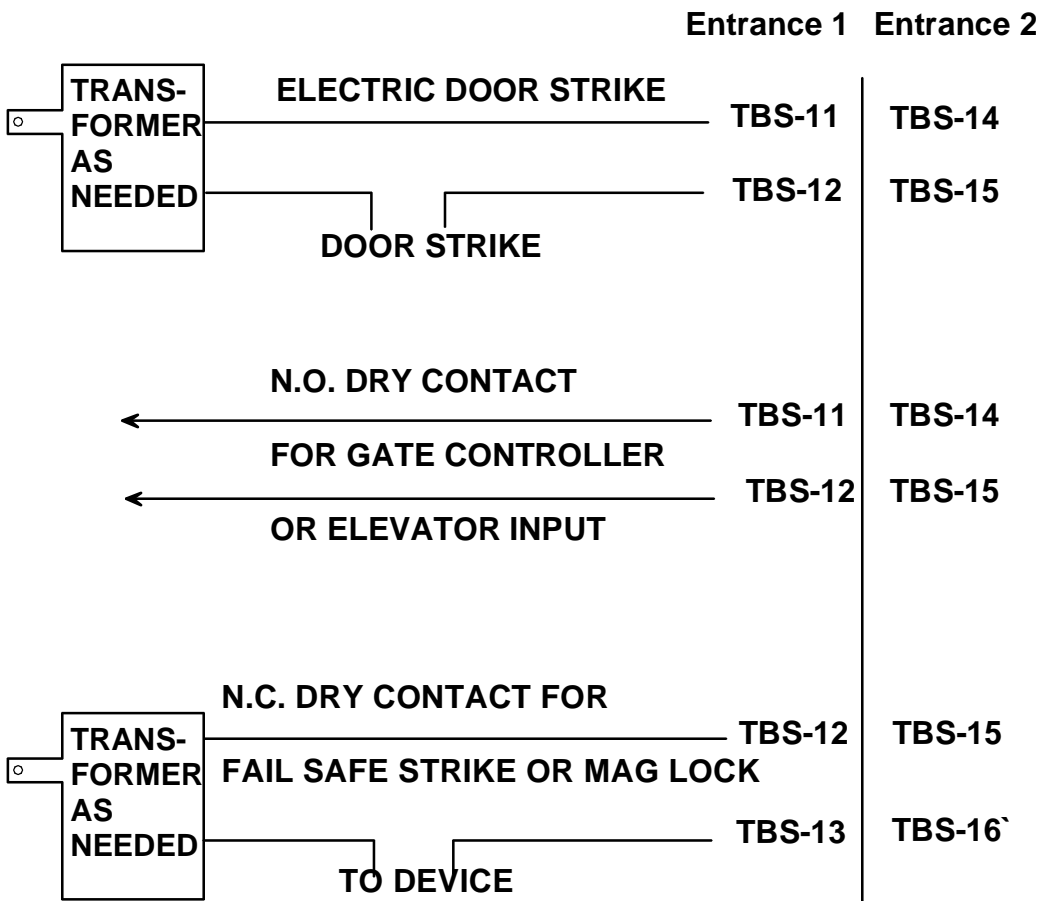
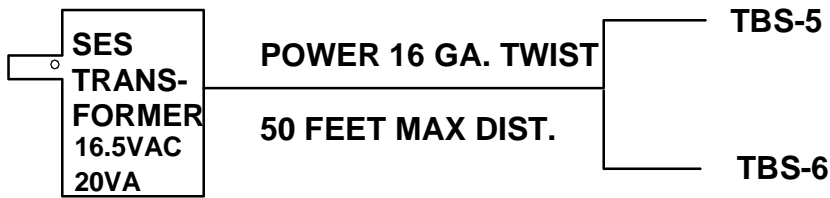
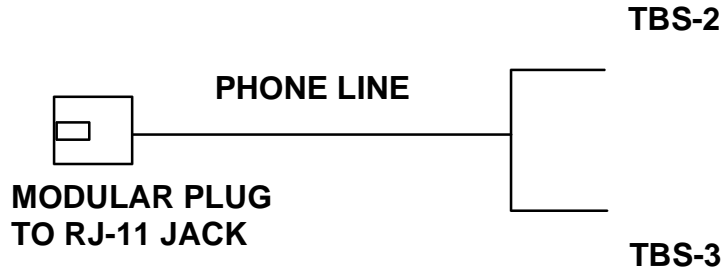

TERMINAL BARRIER STRIP CONNECTIONS

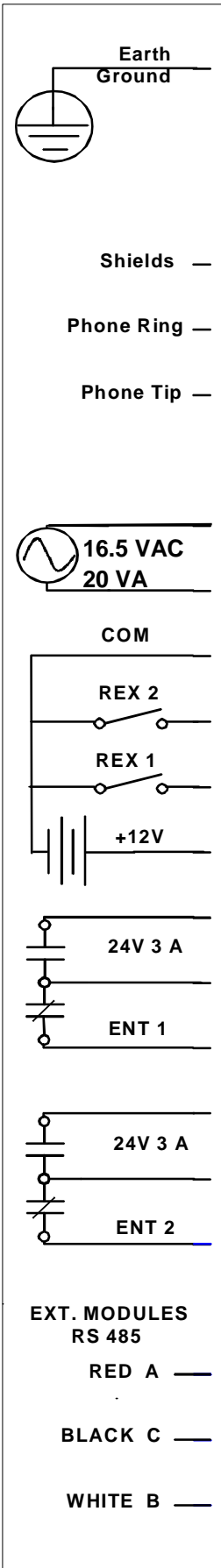

USE 16 GA. OR LARGER
CAT UNIT MUST BE GROUNDED

FOR ALL SHIELDS

TELEPHONE LINE CONNECTS HERE

SES SUPPLIED TRANSFORMER 16 GA. TO 50 FT.

COMMON TO BATTERY AND REX INPUTS

N.O. REQUEST TO EXIT #2

AND OPTIONAL POSTAL LOCK INPUT

N.O. REQUEST TO EXIT #1

BACKUP BATTERY + (POSITIVE)

ENTRANCE #1 N.O.

ENTRANCE #1 COMMON

ENTRANCE #1 N.C.

ENTRANCE #2 N.O.

ENTRANCE #2 COMMON

ENTRANCE #2 N.C.

CONNECTIONS ARE USED TO CONNECT REMOTE CARD
READER MODULES AND REMOTE RELAYS TO THE CAT UNIT.
S.E.S. RECOMMENDS BELDEN 8771 OR CLOSE EQUIVALENT.
MAXIMUM RECOMMENDED LENGTH IS 4000 FT. TOTAL

2 INSTALLATION

DIP SWITCH (SW1) SELECTION DESCRIPTIONS

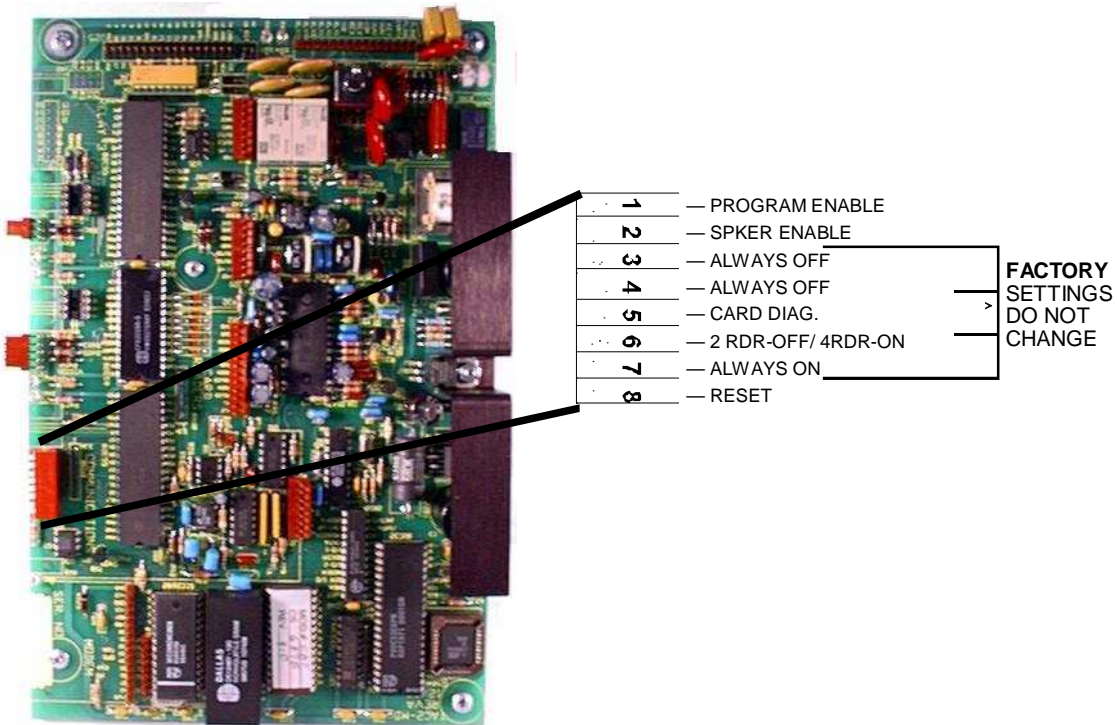

SPEAKER AND MICROPHONE ADJUSTMENTS

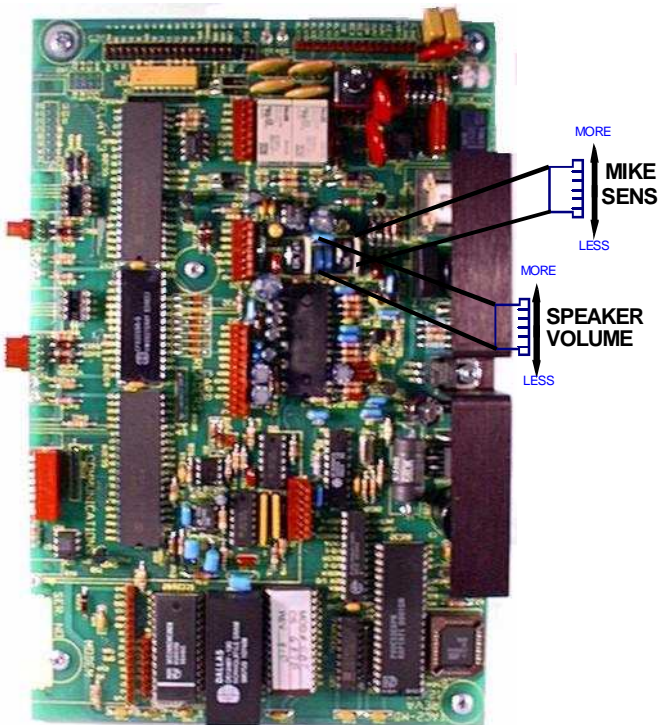

NOTE:
MIKE SENSITIVITY AND
SPEAKER VOLUME
INTERACT WITH EACH
OTHER. IMPROPER
ADJUSTMENT WILL
ADVERSELY AFFECT
PERFORMANCE AND/OR
OPERATION.

POWER SWITCH LOCATION

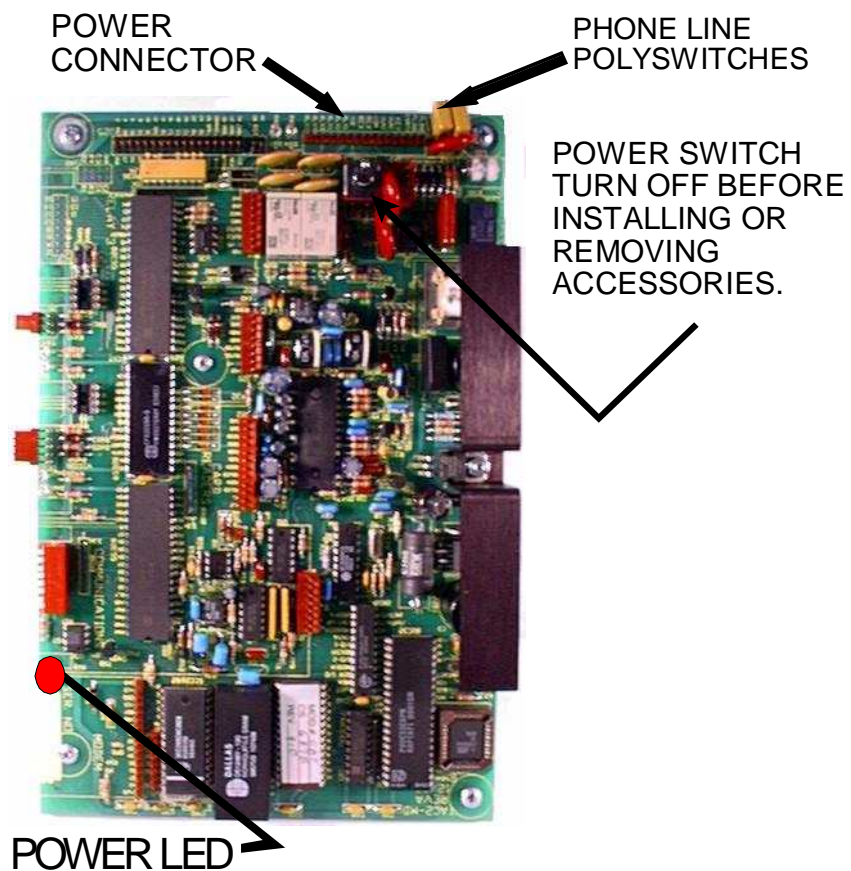

3 ACCESSORIES OVERVIEW

Although some options are not shown, available options are:

- External Card reader(s) input (4 Readers)
- Wiegand, Proximity, RF Transmitter, Barcode (Wiegand output).
- Several reader technologies using Wiegand format signals are available, including Wiegand, Proximity, RF Transmitter, and Long Range Proximity Readers. Wiegand output keypad controllers also may be used in some situations. Contact the factory for particulars on Wiegand output keypads.
- Second signal relay (OPTK2R) has functions for shunt activation and 2 REX inputs.
- Third signal relay (OPTK3R) has functions for CCTV activation, alarm output and 2 tamper inputs.
- Standby batteries (OPTB12V).
- 56k baud modem (OPTKMODEM56K).
- RS-232 port or Current Loop for printer, terminal or computer connections (OPTKPRT)
- Serial Baud rates to printer and/or remote terminal (CRT) 300, 600, 1200, 2400, 4800, 9600, 19200
- Current Loop baud rates- 300, 600, 1200, 2400, 4800, 9600
- NIC2 Card for Networking connections for monitoring and programming
- Multiple units can share same telephone line, via MUIs (OPTKMUI).
- Two minute "sleep" function to allow programming up to 8 CATS with modem.
- Third signal relay (OPTK3R) has functions for CCTV activation, alarm output and 2 tamper inputs.
- Lighted Hood for greater night time visibility

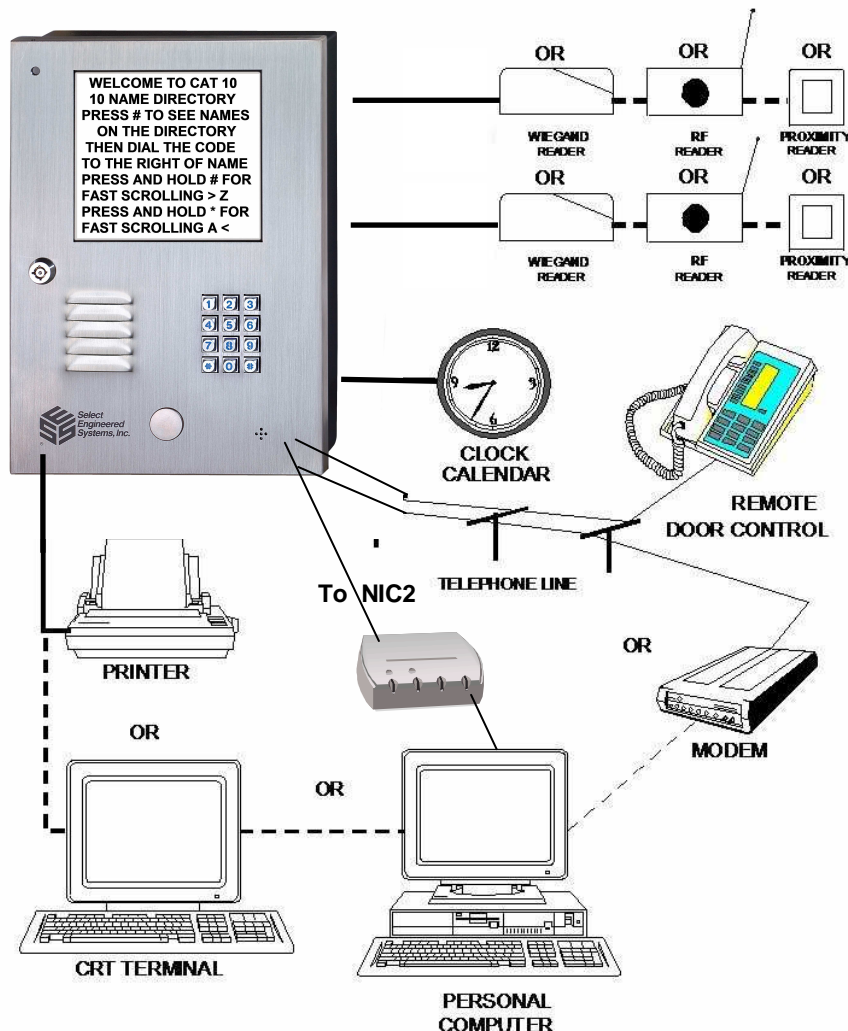

CAT Series v 4.1X

3 ACCESSORY INSTALLATION

WIEGAND INPUT MODULES

The CAT is provided with two or four internal card reader inputs. The card reader modules works with 26 or 30 bit Wiegand format bit streams. There are no LED drive indicator signals on the 4 door reader. Belden 9941 or close equivalent is used to connect readers to the card reader modules.

Card Reader Module Wiring connections

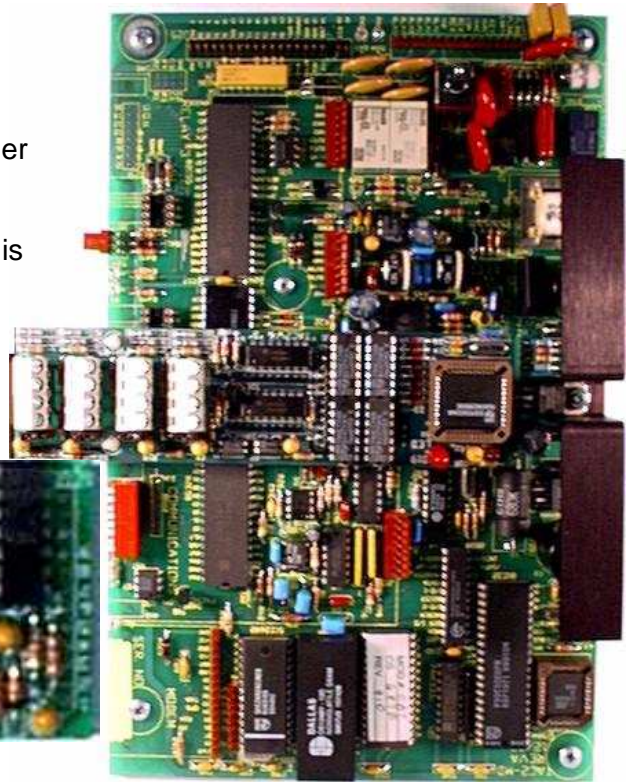
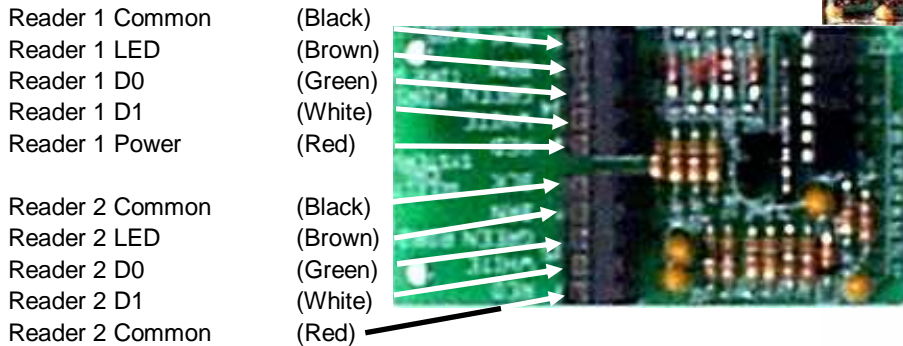

CARD READER VOLTAGE SELECT

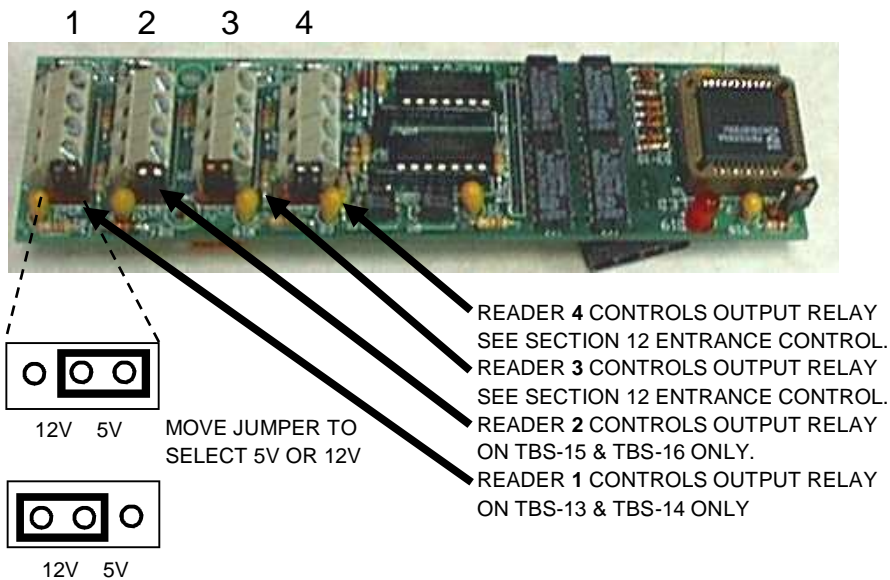

NOTE: MAXIMUM READER CURRENT ON 4-RDR IS 125 MA PER READER.

There are jumpers on the card reader board to select 5 or 12 volts for various reader types. Many WIEGAND swipe, insert or key readers are 5 volts. If the readers and the card option were purchased together, this has already been configured at the factory. If not, see the diagram to select the appropriate card reader voltage setting. Check with the manufacturer of your card reader for correct voltage selection.

Note that the card reader and relay assignments cannot be mixed. Card Reader 1 will ALWAYS control the first relay. This is the relay on the terminal barrier strip to the left of the mother board. Card Reader 2 will ALWAYS control the 2nd relay output on the terminal barrier strip to the left of the mother board. The maximum distance for WIEGAND readers is 500 feet. Belden #9941 or close equivalent must be used for card reader signals. The maximum power consumption available for using on-board power supply is 125 ma. per reader. For readers with greater power requirements, an external power supply MUST be used.

3 ACCESSORY INSTALLATION
 GROUNDING CARD READER WIRING

NOTE: DO NOT WIRE ANY PORTION OF THE CARD READER "HOT." REMOVE ALL POWER BEFORE WIRING ANYTHING TO THE CARD READER.

In the event of servicing one of the older style card reader modules, the signals are described here.

READER 2 1

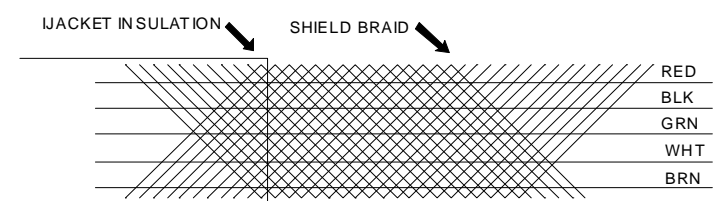
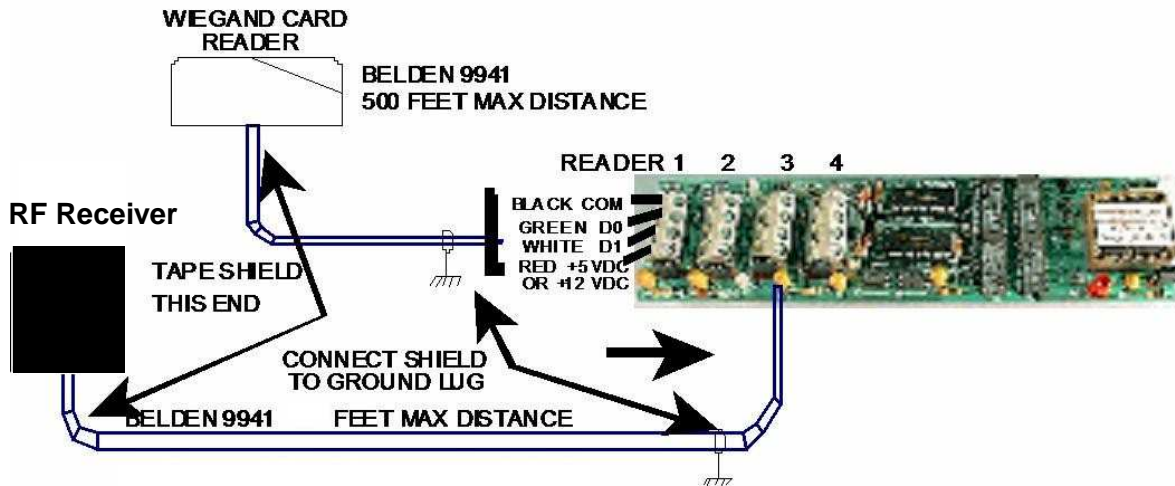
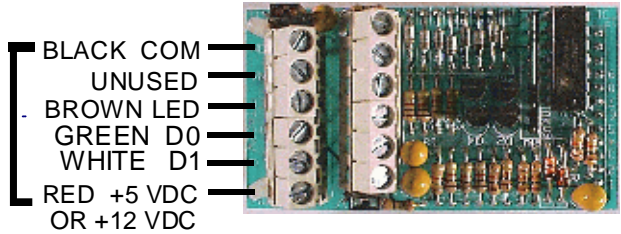

Strip away 3 inches from the outer jacket, as shown at left.

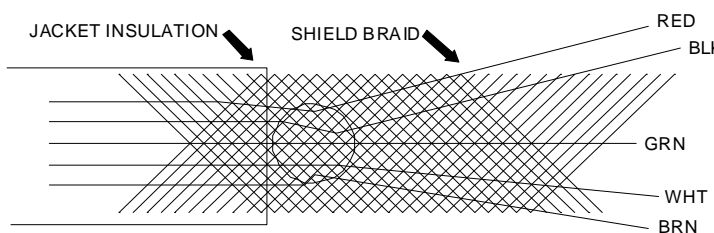

Poke a hole in the braid as shown at left. Spread the braid open, so the conductors are visible. Peel the conductors out, taking care not to damage the insulation on the conductors.

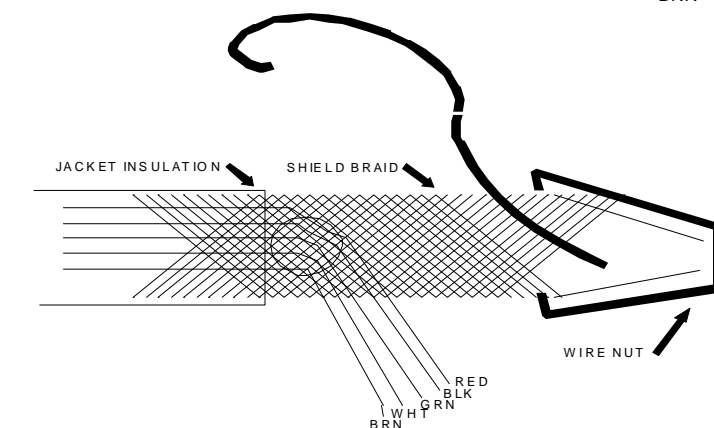

Attach an insulated #18 gauge stranded wire to the shield with a wire nut. Allow enough length for the insulated #18 wire to reach the ground lug in the back of the CAT back box.

Tape the shield from the cable to the wire nut to prevent shorting to any components on the CAT PC board conductors.

CONNECTING CARD READER WIRING

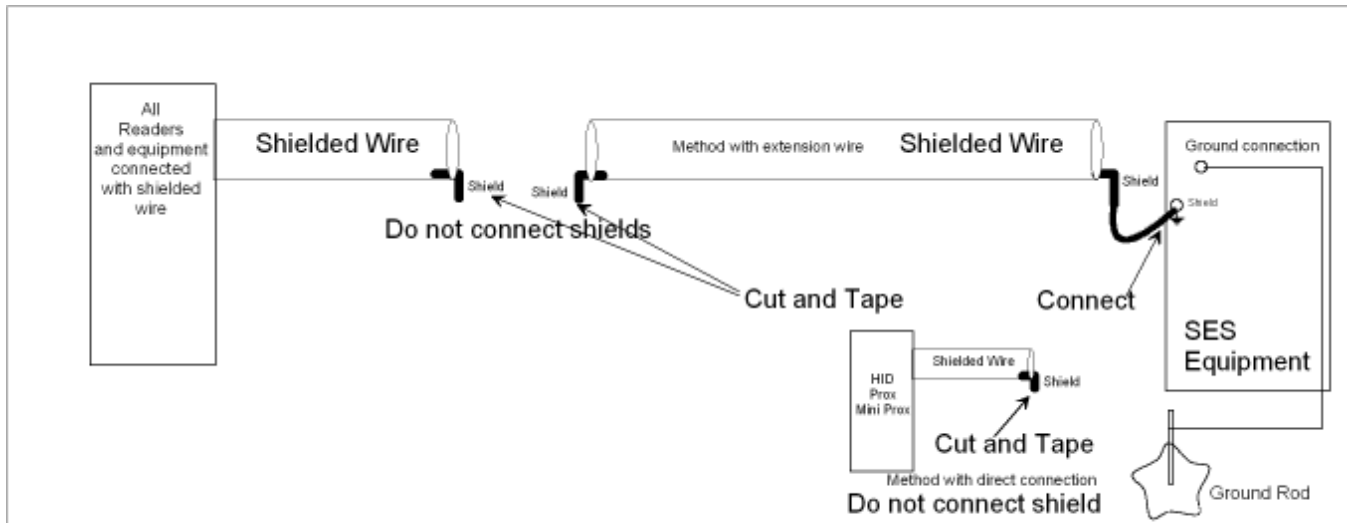

As the above drawing shows, grounding the card reader correctly is very important. Since the ground lug for the CAT is near the top of the unit, take care to avoid shorting the card reader cable shield to components on the mother board.

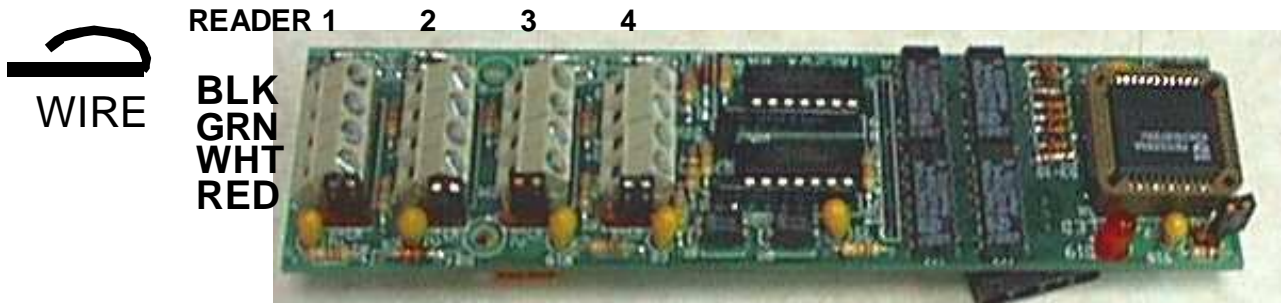

Strip 3/16" insulation from the conductors. Fold the stripped portion of the conductor over the insulated portion. Insert the wire in the clamps of the screw terminals on the card reader board and clamp down by screwing the terminal screw tightly. This ensures a good mechanical connection and an electrical connection that will keep the small wires from breaking.

SETTING WIEGAND FORMAT

While there are several Wiegand output formats, the two used by SES are 26 and 30 bit Wiegand output. The factory default from SES is 30 bit output. To set the bits to 26, enter 260 as a site code number (See Pg 37) To set the bits to 30, enter 300 as a site code number. Neither of these numbers will change the existing Site code.

SITE CODE

To keep a card (for example card number 12345) from being used from another facility, a Site Code is set in the CAT. This is the same as a Facility Code would be in a commercial card reader installation. Set the Site Facility Code using Pg. 37

If the Site code (of the cards) is not known, turn on #5 on the dip switch on the main PC board. This will display card errors on the LCD screen on the front door. Swipe a card through a reader and read the site code error information on the LCD display to determine the Site code. After the Site code is entered turn switch 5 off, to keep swiped card numbers confidential.

To have the CAT unit ignore the site code completely, enter 255 as a site code. This diminishes the security of the facility, as a card from some other facility that was coincidentally the same number as a valid card, could operate the reader. This is sometimes necessary when mixing card technologies on a site, but should only be done as a last resort.

3 ACCESSORY INSTALLATION

CONNECTING EXTERNAL CARD READERS / RELAY MODULES

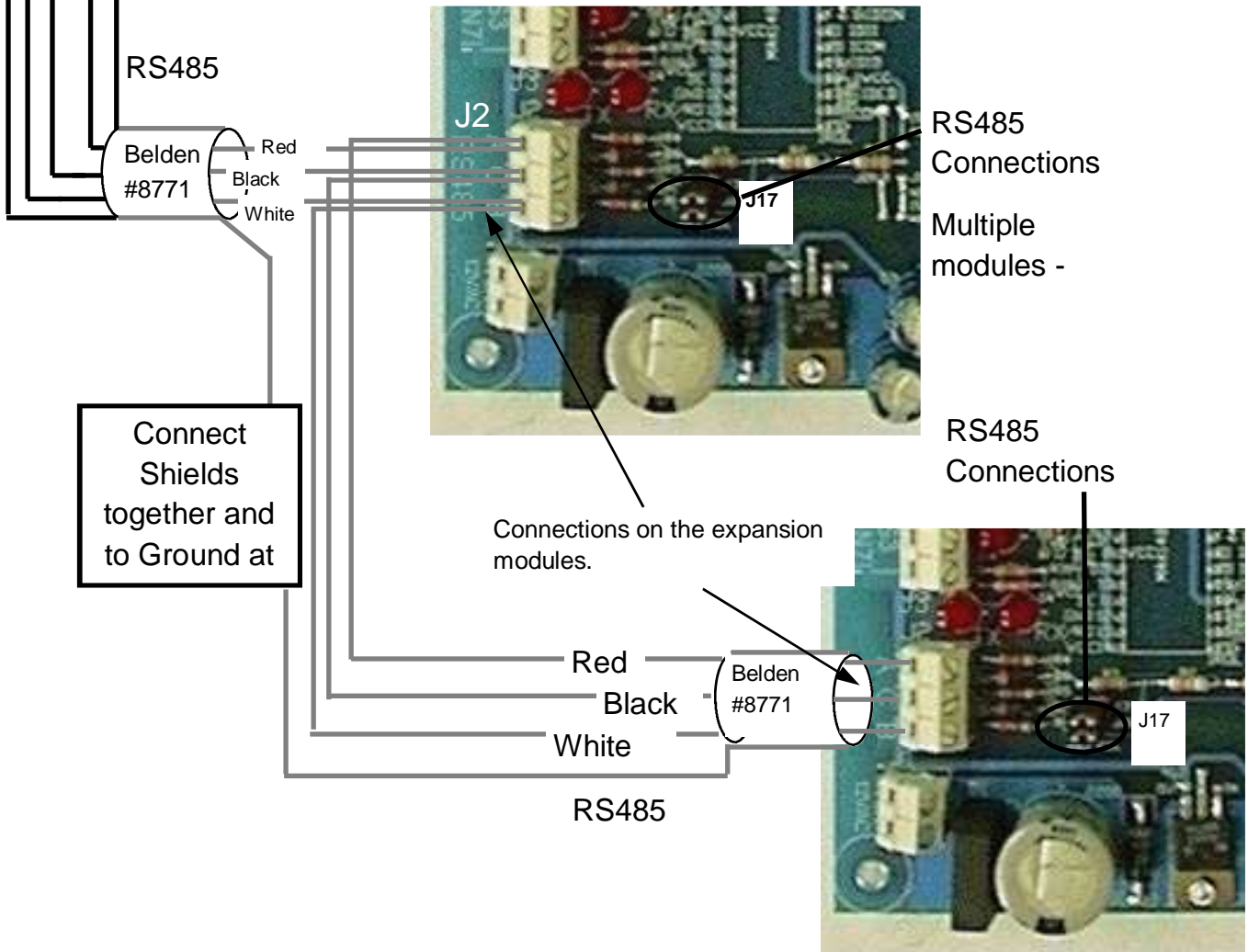
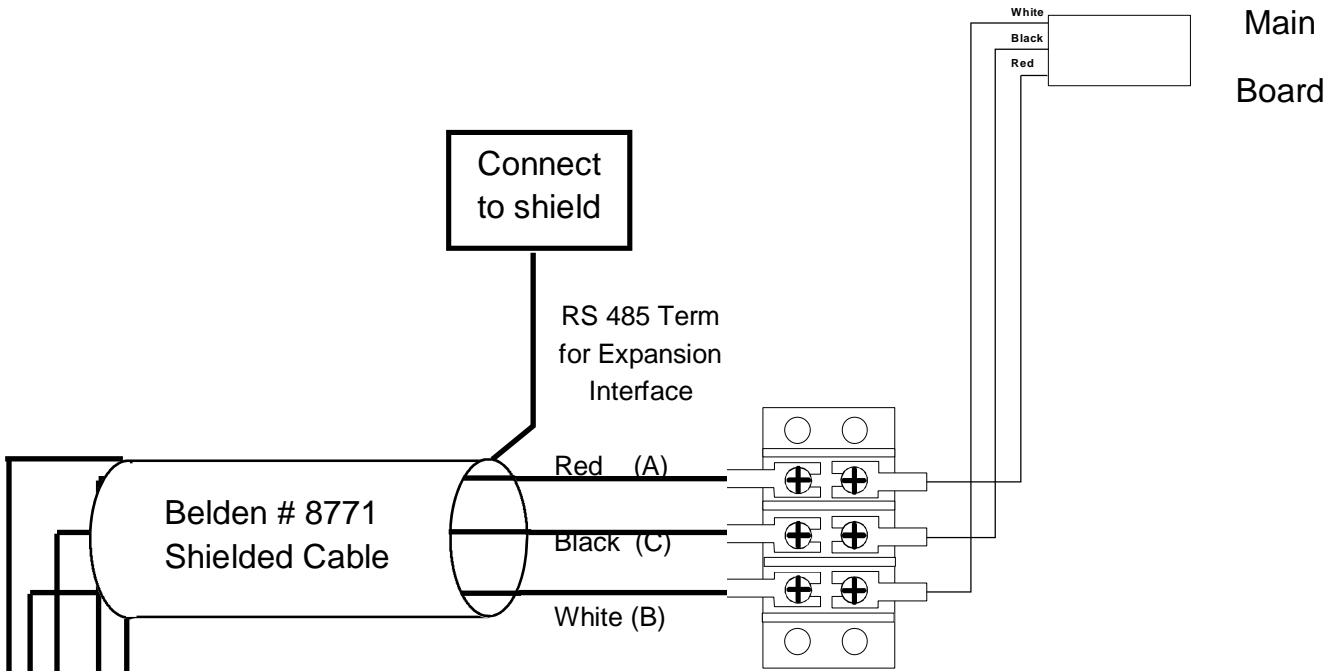

ENTRANCE 3 & 4 CONTROL

Use the control relay module included to control the 3rd and 4th entrances.

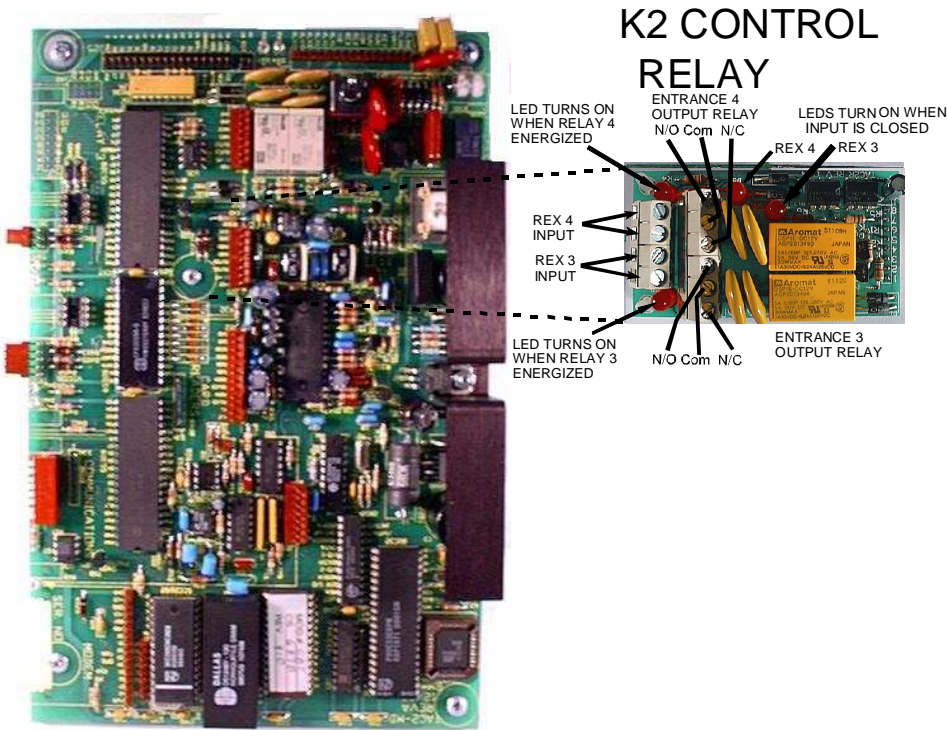

The relay capabilities are 24 volts AC or DC at 3 amps. Form "C" (N/O) AND (N/C) contacts are on the control output relay for controlling devices.

If additional current and or higher voltage capabilities are required, it is recommended that the control relay be used to control a larger relay or contactor. For further questions, consult the factory.

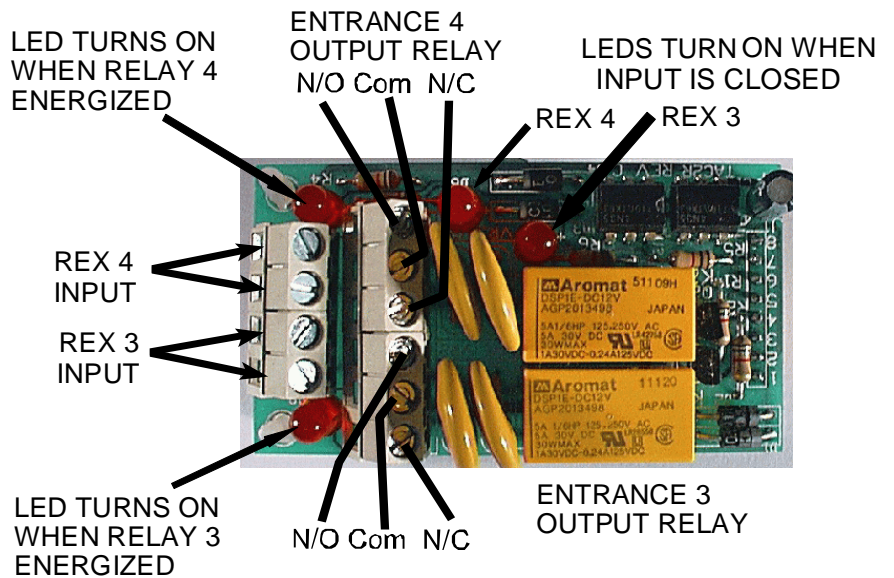

3 ACCESSORY INSTALLATION

ENTRANCE 3 & 4 CONTROL continued..

The REX3 (REquest to eXit) and REX4 signal inputs are "dry" contact inputs only. These inputs are normally open and actuate the relay upon contact closure. To simplify troubleshooting in the field, an LED indicator lights whenever the input signal is closed.

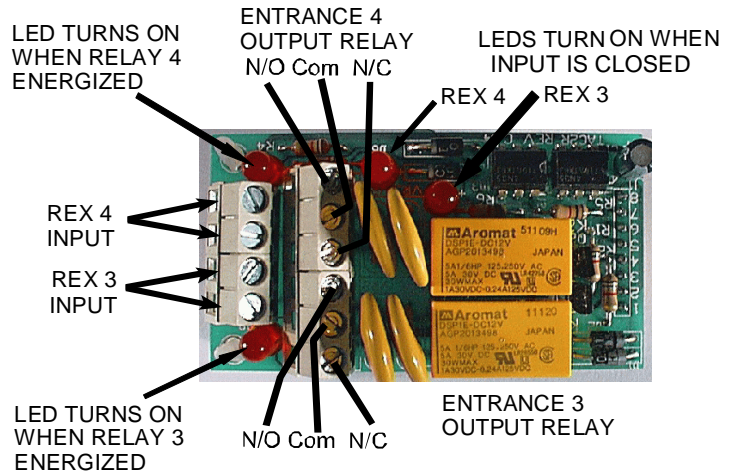

K3 CONTROL RELAY

The optional (OPTK3R) K3 relay is a control & alarm relay module. The control relay is used to control a device any time the CAT is taken off hook. Applications for the control relay of this option include using CCTV equipment with the CAT, or controlling lighting that turns on whenever the CAT is being used for communications. The alarm relay turns on immediately whenever either tamper input on the OPTK3R card is closed. The relay capabilities are 24 volts AC or DC at 3 amp. Form "C" (N/O) or (N/C) contacts are on the control output relay for controlling devices. If additional current capacity or higher voltage capacity is required, it is recommended that the control relay be used to control a larger relay or contactor. For further questions, consult the factory.

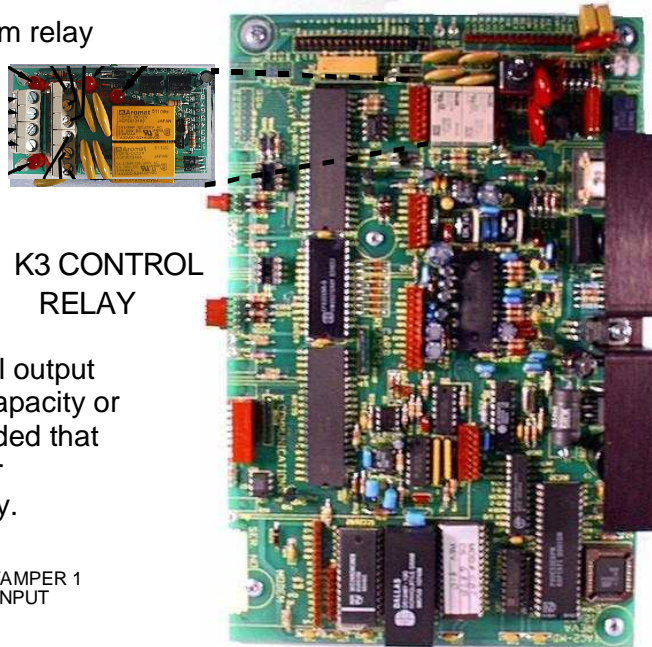

LEDS TURN ON WHEN INPUT IS CLOSED

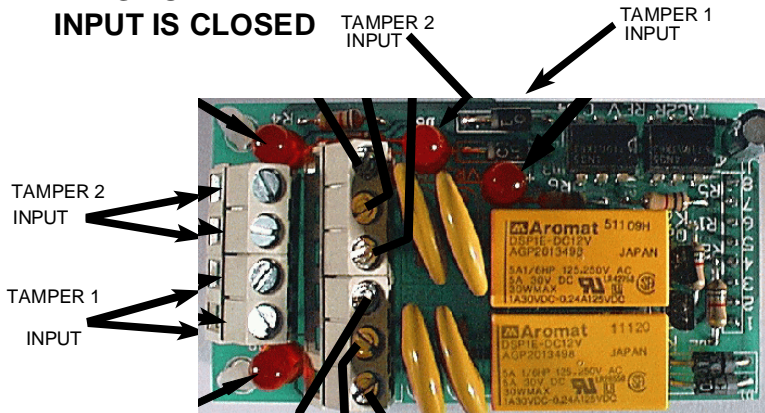

The two tamper signal inputs are "dry" contact input only. These inputs are normally open and actuate the alarm relay upon contact closure. To simplify troubleshooting in the field, an LED indicator lights whenever the input signal is closed

NOTE: TAMPER INPUT SIGNALS REPORT "CLOSED" AND "OPEN" STATES TO THE LOGGING PRINTER.

NOTE: When the alarm time is set to "0" the K3 relay function changes to the "Shunt" function and the inputs change to "Door Sense" inputs for Entrance 1 & 2 when a four input wiegand reader module is attached.

SERIAL PORT ADAPTER

PRINTER The optional RS-232 serial port adapter (OPTKPRT) may be used to send information from the CAT to a serial printer. Information may be transmitted to the printer at rates from 300 baud to 19200 baud. Baud rate may be selected from the communications setup menu. Because CAT printer messages are relatively short, a busy signal control is usually not required. The busy signal is only active for systems that have a transaction buffer (See Pg. 20). If the BSY signal is used it can be inverted from high going to low going as required by some printers by removing jumper J-3. The only connections usually required for a printer are RX (Received Data, pin 3) and GROUND (pin 7). Connect the TX terminal on the serial port adapter to the input of the printer. It may be called RX, RCV, Data In, or some other label. Connect the serial port adapter ground to printer ground (may also be called common).

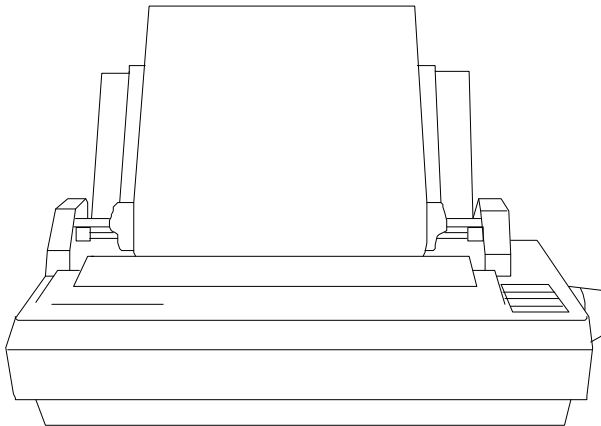

THE PRINTER SHOULD BE SET TO 8 BITS, NO PARITY BIT, AND 1 STOP BIT (8,N,1).

Consult the manual for your printer to set your printer to these parameters. SES has an optional printer that is set correctly at the factory. Because of the wide variation in printers on the market, SES cannot make specific recommendations for printers that are not purchased from SES.

NOTE: SHIELDED CABLE MUST BE USED AND THE SHIELD MAY NOT BE USED AS A SIGNAL PATH.

J2 MUST BE JUMPERED

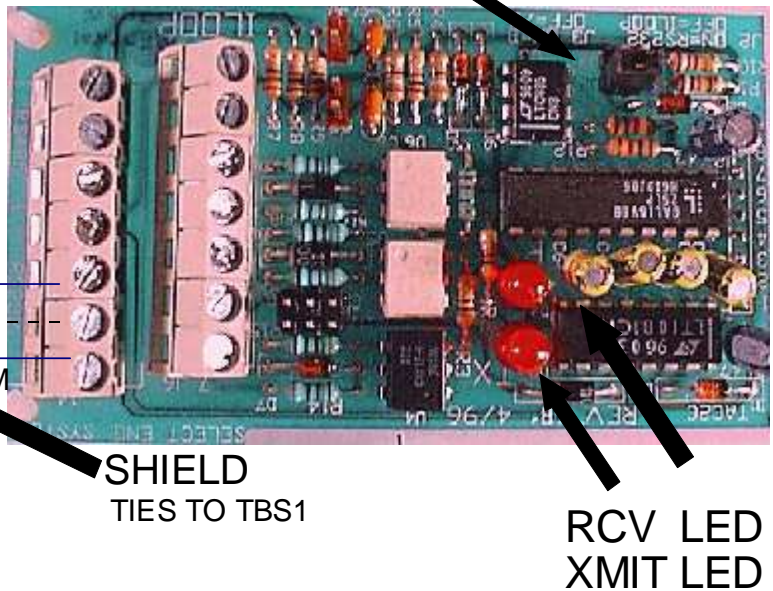
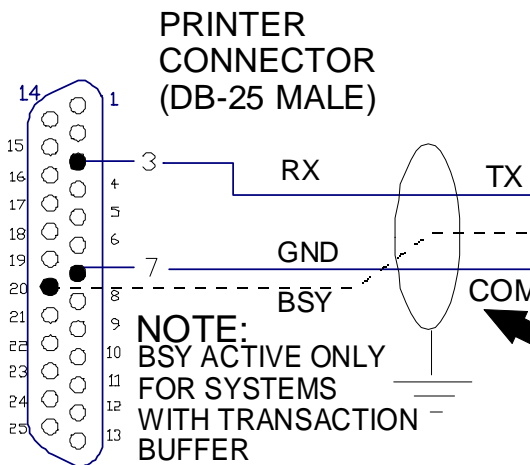

PRINTER REPORTS AND MESSAGES

If a printer is attached to the CAT, this start up message will print when the TEC is first powered on.

S.E.S. CAT 2R

VER 4.XX (where X.XX is a version and revision number)

00:00/00/00 (where 00:00 is the time, and 00/00/00 is the date.)

The time and date may not be correct until the time and date are set. See 38 - 39 for SETTING TIME DATE to set the clock.

PRINTER REPORTS AND MESSAGES continued

Some examples of typical logging report messages are shown below.

```

PROGRAMMING MODE ENTERED ON KEYPAD 00:00/00/00
EXIT PROGRAMMING MODE 00:00 00/00/00
ENT 1 LATCHED OPEN BY CLOCK 00:00 00/00/00
ENT 2 LATCHED OPEN BY CLOCK 00:00 00/00/00
CARD 00790 CODE 003 MORRIS, NORMAN ENTRANCE 1 OPEN 00:00 00/00/00
CARD 01291 CODE 002 DAVIS, JIM LEVEL NOT SET READER 2 00:00 00/00/00
CODE 004 SHEPARD, JULIUS DIALED 00:00 00/00/00
CODE 004 SHEPARD, JULIUS ENTRANCE 2 OPEN 00:00 00/00/00
ENT 2 LOCKED 00:00 00/00/00
CARD 00257 CODE 003 DOE, JOHN DAY NOT VALID READER 2 00:00 00/00/00
CARD 00260 CODE 002 CHAVEZ, CAESAR OUTSIDE TIMEZONE READER 2 00:00
00/00/00
CARD 00764 CODE 004 SHEPARD, JULIUS INVALID ENTRANCE 1 00:00 00/00/00
PIN 0001 CODE 001 BROWN, BOB OUTSIDE TIMEZONE ENTRANCE 1 00:00 00/00/00
ENT 1 LOCKED 00:00 00/00/00
CODE 000 PASTOR, JOHN DIALED 00:00 00/00/00
CALLER HUNGUP 00:00 00/00/00
TAMPER 1 CLOSED 00:00 00/00/00
TAMPER 1 OPEN 00:00 00/00/00
PIN 0003 CODE 003 DOE, JOHN DAY NOT VALID ENTRANCE 1 00:00 00/00/00
INVALID CODE 911 ATTEMPTED 00:00 00/00/00
PIN 911 WALLACE, WILL ENTRANCE 1 OPEN 00:00 00/00/00
ENT 1 LOCKED 00:00 00/00/00

```

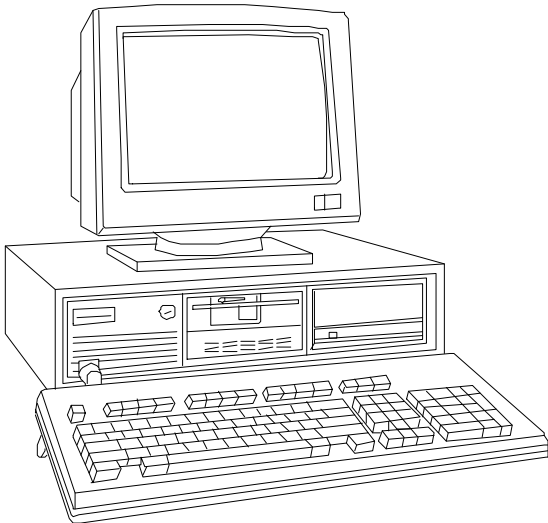
CONNECTING A PERSONAL COMPUTER TO THE SERIAL PORT

The CAT may be remotely programmed by personal computers that already have a terminal communications program. Set the communications parameters to the CAT default, 9600 baud, 8 bits, 1 stop bit, No parity, (8,N,1) going from the COMM port on your computer to the serial board on the CAT. Check the CAT from the keypad on the front of the CAT to make sure that the CAT communications parameters are also set to 9600 baud. If your software supports terminal emulation, set it to VT-100B emulation. If it does not, program the CAT terminal type from VT-100B to "dumb" terminal mode. See Pg. 36. To start communications press the "Esc" (escape) key on your computer. Do not press any other keys until the PASSWORD prompt appears on the CRT screen of your personal computer:

PASSWORD

You have 10 seconds to begin entering the password. If you wait more than 10 seconds before entering the password the CAT will revert back to normal operation and you will have to re-enter the "Esc" key again. All CAT systems leave SES with a factory password of 777777. As the password is entered, the screen will replace each character with an "*" to keep the password confidential. After the password is entered, the main menu will be displayed. If more than 60 seconds elapse without a keystroke, the CAT will disconnect. It will then be necessary to press "Esc" (escape) and start again.

CAT Series v 4.1X**CONNECTING A PERSONAL COMPUTER TO THE SERIAL PORT**

Use with standard DB9 Cable or connect with wire.

Available with 90 degree connector, upright connector (T101 style shown) or current loop.

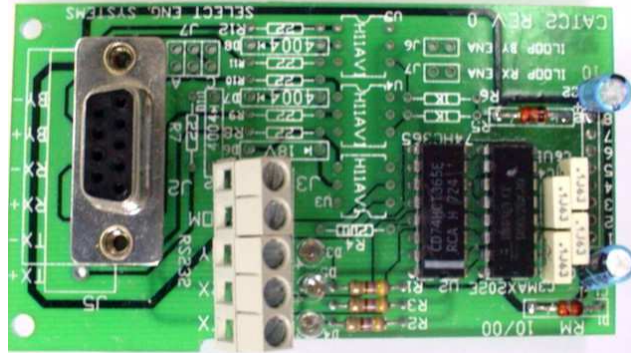

If you have any problems getting the "PASSWORD" message on your personal computer, it may be necessary to check your personal computer's operation. The best way is to remove the TX and RX wires from the CAT serial port adapter and temporarily connect them together. This is called "echo" or "loop back" and will verify terminal connections. While operating the terminal software program, pressing a character on the terminal should echo the same character to the screen. Now re-check this by disconnecting the TX and RX wires, and echoing a character. This time, nothing should echo to the screen.

Until you can verify this operation, there is no need to connect the personal computer to the CAT serial board. The most common problems are either wiring disorders or incorrect COMM port selection in the software used by the personal computer.

Once "loop back" has been verified, the LED lights on the serial board can provide information as to system status. The receive (RCV) LED should flicker briefly every time a keystroke is sent from the personal computer keyboard. The transmit (XMT) LED will flicker or remain on every time the CAT sends a signal to the personal computer screen. Have someone access the CAT from the front keypad and print a report. The XMT LED will stay on for the duration of the report.

TERMINAL Connecting a terminal to a CAT series unit is similar to connecting a personal computer. The diagram on the next page shows the connections necessary to operate most CRT terminals with a CAT. Connect ground to the CRT terminal ground. Connect TX from the serial adapter port to RX of the CRT terminal. Connect RX from the serial port adapter to TX of the CRT terminal.

The communications parameters for the terminal to communicate with the CAT are: 8 bits, No parity, 1 stop bit (8, N,1). If your terminal supports emulation modes, set the emulation to VT-100B. If it does not, program the CAT terminal type from VT-100B to "dumb" terminal mode. (See Pg. 36) The CAT leaves SES set at 9600 baud. Set your terminal to this speed. Belden cable # 9925 (or equivalent) can be run for distances up to 100 feet. For greater distances, consult factory.

After the terminal is connected and powered on, press the escape key <Esc> once. This prompt will appear on the CRT screen:

PASSWORD

You have 10 seconds to begin entering the password. If you wait more than 10 seconds before entering the password the CAT will revert back to normal operation and you will have to re-enter the "Esc" key again.

All CAT systems leave SES with a factory password of 777777. As the password is entered, the screen will replace each character with an "*" to keep the password confidential.

After the password is entered, the main menu will be displayed. If you have any problems getting the "PASSWORD" message on your terminal, it may be necessary to check your terminal's operation. Use the procedure above for computer as the communication method is the same.

Some terminals have hardware "handshaking" signals that need to be connected in order to achieve proper operation. Refer to your terminal manual for correct connections. The drawing below shows the most common configuration for terminals, and may be of some use if information for your terminal is not available. . Due to the large number of terminals on the marketplace, SES is unable to provide technical support for terminals not purchased from SES.

3 ACCESSORY INSTALLATION

CAT Series v 4.1X

14.0 Serial Port Adapter continued

TERMINAL WIRING CONNECTIONS

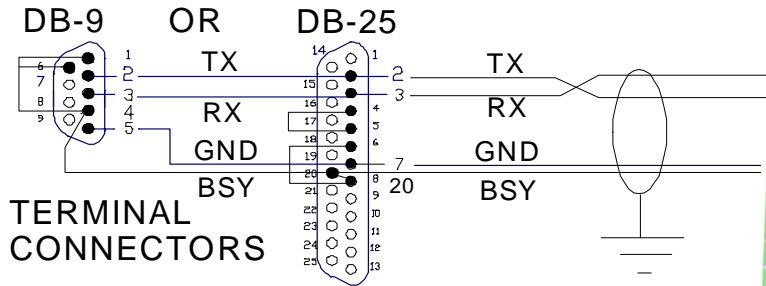

Use with standard DB9 Cable or wire.

Available with 90 degree connector, upright connector (T101 style shown) or current loop.

CURRENT LOOP

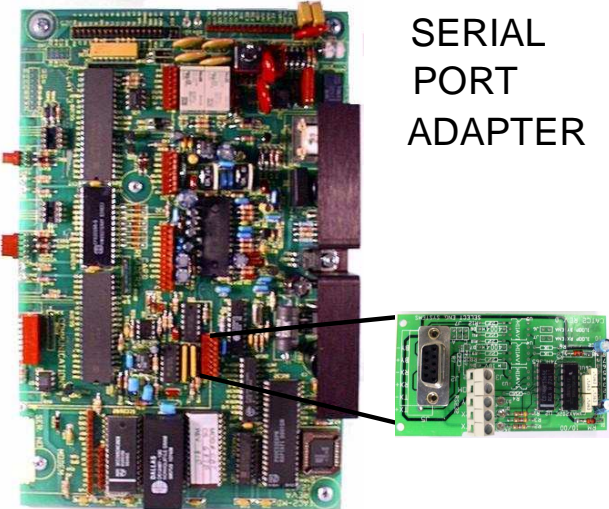

SERIAL PORT ADAPTER

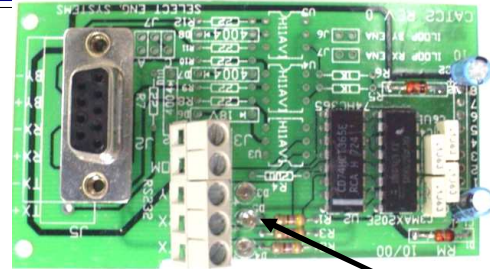

Send Receive Lights

For communications that must occur a longer distance than 100 feet, (but less than 1000 feet) the current loop may be used instead of the RS 232 signals. The three loops supported are the busy loop, the receive loop and the transmit loop.

Because CAT printer messages are relatively short, a busy signal control is not usually required. The busy loop is only active for systems that have a transaction buffer (See Pg. 52). The ground and the transmit loop are the only signals usually required for a printer. Information may be transmitted to the printer at rates from 300 baud to 9600 baud. Many serial printers that support current loop, restrict the speed to 1200 baud. Baud rate may be selected from the communications setup menu (see Pg. 52).

NOTE: SHIELDED CABLE MUST BE USED AND THE SHIELD MAY NOT BE USED AS A SIGNAL PATH.

For current converters that are not active current sources, a current source may be selected from the board by placing a jumper (for example, a jumper on J7-A for the transmit signal) at J-7. This will provide a current loop source of approximately 20 ma. for a maximum distance of 1000 feet. Each signal that needs a current source requires a jumper as shown below.

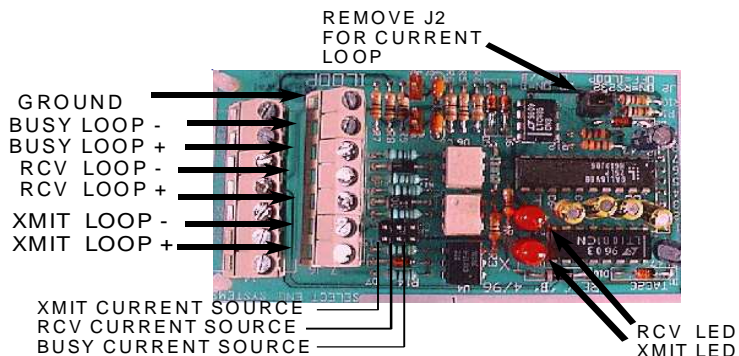

A recommended cable is Belden # 8770. The shield connects to the ground lug on the terminal barrier strip inside the CAT housing (see Pg.7).

Whenever a signal is transmitted from the CAT to the printer the lower TX (transmit) LED will blink briefly. The transmit and receive LED's should help in connecting and troubleshooting serial port connections. For use as a terminal, the transmit (XMIT) and receive (RCV) loops

must be connected to the appropriate current loop converter. After the terminal is connected and powered on, press the escape key <ESC> once. This prompt will appear on the CRT screen:

PASSWORD

You have 10 seconds to begin entering the password. If you wait more than 10 seconds before entering the password the CAT will revert back to normal operation and you will have to re-

enter the "Esc" key again. All CAT systems leave SES with a factory password of 777777. As the password is entered, the screen will replace each character with an "*" to keep the password confidential. After the password is entered, the main menu will be displayed.

3 ACCESSORY INSTALLATION

CAT Series v 4.1X

NIC2 Card

The NIC2 (Network Interface Card) provides a plug-in TCP/IP and RS-232 serial interface for all CAT products.

See the NIC2 Card Instruction sheet for further Info.

- TCP/IP network compatible ONLY.
- Compatible with all CAT products running Selcom 7 or newer
- Requires the end user to have a qualified network manager for setup.
- Capable of up to 99 NIC2s on a single network when running Selcom Secured.

The SES NIC2 Network Interface is used to provide a Programming and Data connection to a SES CAT or TEC Telephone Access Controller through a local area network. The SES Network Interface provides for conversion of the standard serial interface in the SES CAT or TEC controller to a TCP/IP connection. All portions of the connection must operate at the same speed and connectivity settings. We are pre setting the selections to 9600 baud, 8 bits, no parity, 1 stop bit. Each interface is provided with a unique hardware address. The network system administrator provides an IP address that is assigned to the unique hardware address. Each SES Network Interface is then assigned a unique port address on the network. A standard range of port addresses is provided, that are normally not used in most networks.



NIC2 Network Interface Card

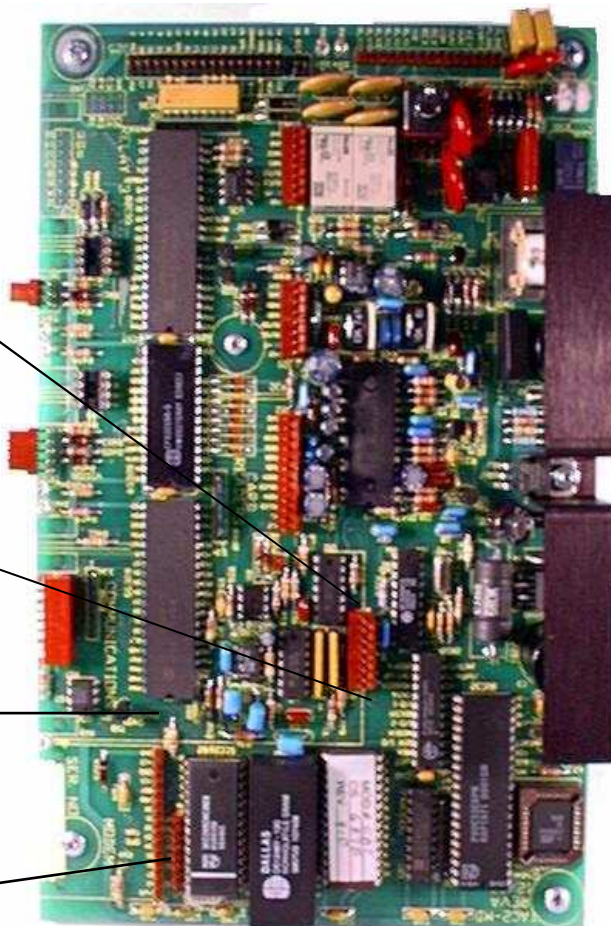
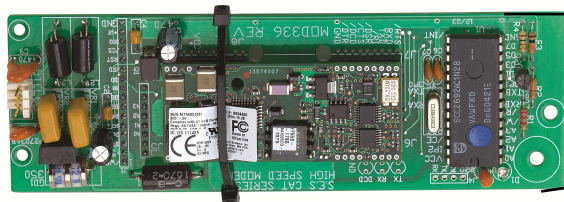

MODEM ADAPTER

The 56.6K baud modem adapter (OPTKMODEM566) is included in a CAT.

To service a modem on the CAT, toggle the power switch off (or remove the power connector) on the CAT. Next, plug in the modem making sure that both connectors are seated correctly and the nylon standoffs are connected to the main PC board. There is an additional standoff in the lower right corner of the PC board that also has to be mounted. Connect the phone line connector cable at the left edge of the board to Terminals TBS-2 and TBS-3 on the terminal barrier strip to the left of the PC board. This is where the existing phone line to the CAT is also connected. Then, toggle the power switch on (or reconnect the power connector). The modem operates at 1200 through 56.600 baud. The communications protocols for the modem are: 57000 baud, 8 bits, 1 stop bit, No parity (8,N,1).

When the 56.6K baud modem is on, it kills power to the card reader module, since cards can not be used when the CAT is in programming mode.

MODEM COMMUNICATIONS continued

The CAT modem functions like any other modem. It can be called from a personal computer that has its own dial-up modem (either external or internal), and uses some form of terminal communications program, or a CRT terminal connected to a modem.

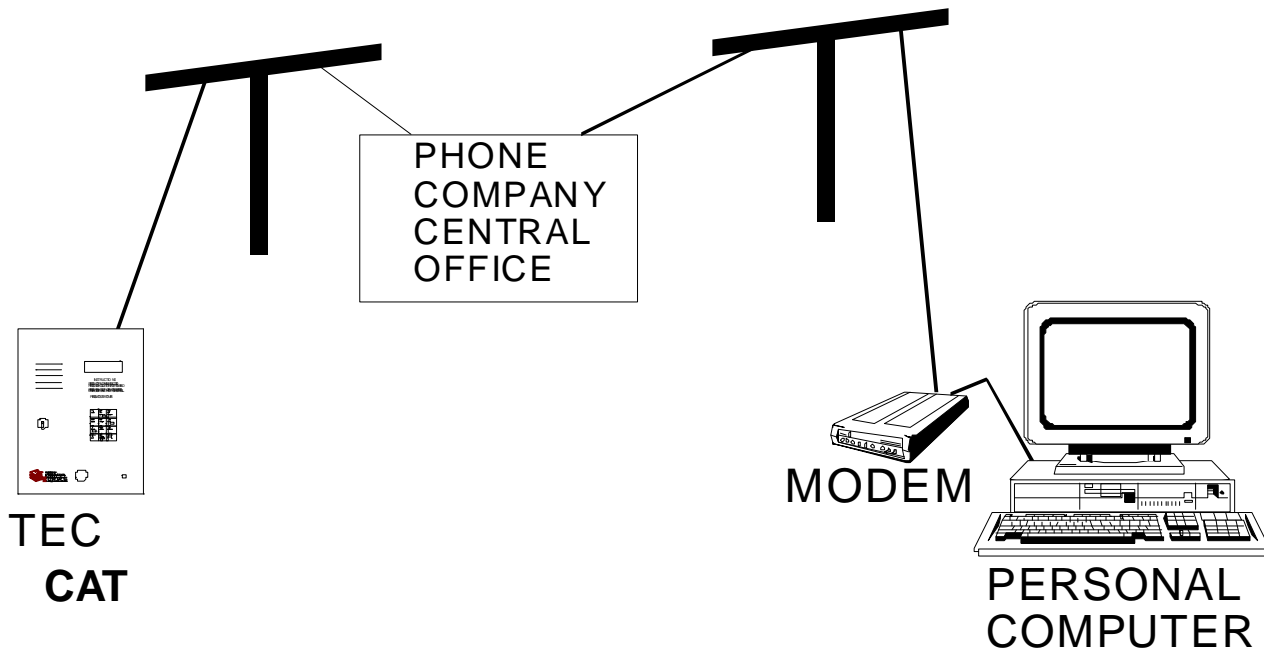

For computers equipped with Windows, the optional Selcom Secured 7 (or newer) may be used to control the CAT series unit. This program has many features, including automatic upload (sending information to the CAT unit) and automatic download (getting information from the CAT series unit).

COMPUTERS WITH OTHER TERMINAL PROGRAMS

If another terminal communications program is used, interactive control of the CAT is possible, but uploading and downloading of information is not possible. Uploading and downloading requires Selcom 7 or Newer. Set the terminal communications parameters to Modem Installed, 8,N,1 and Vt-100 emulation, then call the phone number attached to the CAT. The required dial out prefix for most Hayes™ compatible modems should be ATE1V1S7=180DT and the phone number. If your software supports terminal emulation, set it to VT-100B emulation. If it does not, program the CAT terminal type in Pg. 52 from VT-100B to "dumb" terminal mode. When the personal computer calls the CAT, it will answer after 3 rings (this assumes the factory default of three rings has not been changed). After the modems begin communicating, the message CONNECT XXXX will appear on the screen. If the message CONNECT appears without being followed by XXXX, then the modem has dropped down to 300 baud. Either the phone line signals are noisy or your personal computer modem may be capable of only 300 baud. Next, this prompt will appear on the CRT screen of your personal computer:

PASSWORD

You have 10 seconds to begin entering the password. If you wait more than 10 seconds before entering the password the CAT will revert back to normal operation and you will have to call the CAT again.

All CAT systems leave SES with a factory password of 777777. As the password is entered, the screen will replace each character with an "*" to keep the password confidential. After the password is entered, the main menu will be displayed. If more than 60 seconds elapse without a keystroke, the CAT will disconnect. It will then be necessary to call the CAT again. In order to prevent unauthorized persons from accessing the CAT through a phone line the CAT will disconnect if any keys are entered before the PASSWORD appears on the screen. To exit from programming, press the "Esc" (escape) key. Due to the large number of communications programs, it is not possible for SES to support any terminal communications programs except Selcom 7 or Newer.

CAT Series v 4.1X

MUI

The Multiple Unit Interface (OPTKMUI) is an optional device that allows up to 8 CAT's to share a phone line. While it is preferred that each CAT have its' own phone line, it is sometimes necessary to share an existing line for cost effectiveness.

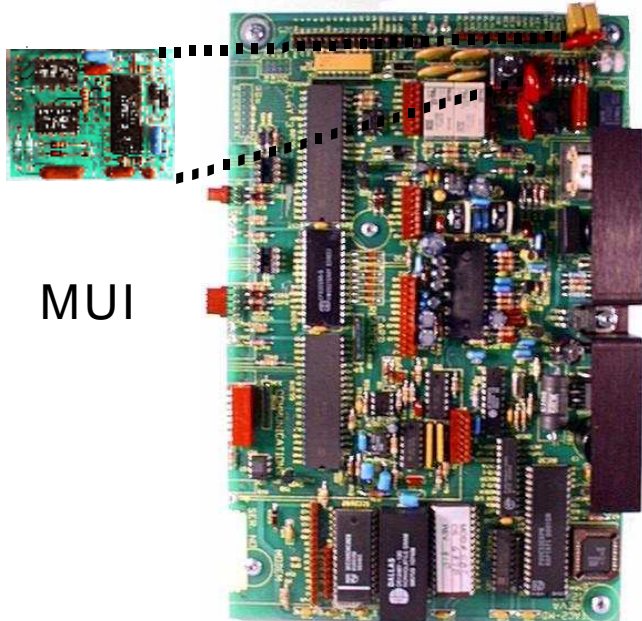

MUI

Whenever a CAT goes off hook, all other CAT units sharing that same phone line will display a "Phone Line Busy Please Wait" message on the LCD display. The MUI also is required for installations that use modems but want to share phone lines with other equipment that also makes use of modems. Something to consider when deciding how many phone lines to get for a multiple unit installation, is the number of residences each CAT will call. This will help determine the optimum number of phone lines in balancing cost versus convenience against anticipated telephone usage. To install a MUI, power down the CAT, and plug the module into the header. MUI's may be attached to their common phone line by running the phone line pair from CAT to CAT, or from some common point to all CAT locations. This provides a lot of installation flexibility.

TWO-MINUTE LOCKOUT

The CAT modem normally disconnects from the phone line when it receives an escape signal after programming has been started. For multiple CAT installations, that share phone lines (using MUI's) it is necessary to temporarily disable the CAT.

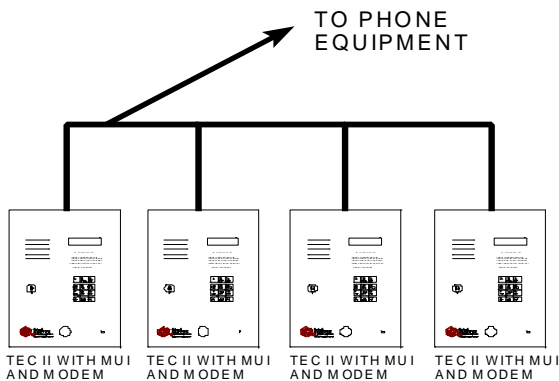

This is because modems can not currently share the same phone line (Their signals would interfere with each other). This is handled automatically in Selcom 7 or Newer software. For users of other terminal programs, to temporarily keep a CAT that has an MUI from responding, instead of exiting programming with an "Esc" (escape) key, use "Ctrl T." This means to press and hold the Control (Ctrl) key followed by the "T" key. (The "T" key may be lower case, it is not necessary to press the shift key). In the example at left, 4 CAT's are sharing a single phone line. The one at the extreme left has had it's ring count set to 2. The next one is set to ring count 4. The 3rd one is set to ring count 6, and the last one is set to ring count 8. This is the number of rings the CAT will listen to before it answers. To program the 1st CAT,

call it from your computer (or terminal) equipped with a modem. It will answer after the 2nd ring. After programming is completed instead of pressing the "Esc" (escape) key, press "Ctrl T." This will busy out the 1st CAT for up to 2 minutes. Now call the same number again. After 4 rings the 2nd CAT will answer. After programming, exit with "Ctrl T." Calling back a 3rd time will busy out the first 2 CATs and cause the 3rd CAT to answer after 6 rings. After programming, exit with "Ctrl T." Calling back the 4th time will busy out the 1st 3 CATs and the 4th CAT will answer after 8 rings. Exit programming with the "Ctrl T" key. After 2 minutes without the phone line in use, all CATs will be ready to be used for normal operation. Users of Selcom 7 or newer can automate this procedure. Check the Selcom 7 instructions.

The above paragraph on the MUI shows that up to 8 CATs may be connected to a phone line. If CATs are equipped with modems it is recommended that a maximum of 4 CATs be connected to the same phone line. Noise "glitches" on the phone line might be erroneously interpreted as a ring signal by the CAT. Selcom 7 or newer will warn you if the wrong unit connects.

This page left intentionally blank

Setup refers to configuration of a CAT, usually during installation. This may include how long the door entry time is, or what number energizes the door control relay. Any options such as card readers or automatic unlock and re-lock, are configured at this time. The installer of the CAT generally performs these tasks.

Programming refers to the entry of codes, names, phone numbers, and PINs (Personal Identification Numbers). The end user or customer generally enters the data, and periodically updates it as required.

If the factory defaults shown on Pg. 28 and 29 are adequate for an installation, then the following "Quick Programming" section will give an example of a typical code entry. No explanations about menu selection function will be provided. SES strongly recommends that installers without previous experience in telephone entry control systems read this manual in it's entirety.

QUICK KEYPAD PROGRAMMING EXAMPLE

This example assumes all factory defaults, including factory default passcode 777777 are in the CAT and you have entered no other data. This benefits those with experience installing and programming telephone entry systems.

This example enters the following data into the CAT from the keypad on the CAT front door:

CODE:	NAME:	PHONE:	PIN:
001	SMITH,FRED	555-1234	1234
123	DOE,JOHN	555-9876	5678

1. To begin programming press the "*" and the "0" keys simultaneously.
2. Enter passcode number 777777.
3. Press *.
4. Press 1.
5. Press 1.
6. Press 001*.
7. Press 7777#6#444#8#44#1111#333#777#33#3#*5551234*1234*.
8. Press 123 *.
9. Press 3#666#33#1111#5#666#44#66#*5559876*5678*.
10. Press the "*" and the "0" keys simultaneously.

Press the # key twice. You should see both codes and names in the display (one after the other). If you had any problems entering the data, or if you did not understand the reason for a key entry, please read the rest of this manual.

4 SETUP AND PROGRAMMING

REMOTE TOUCH TONE CONTROL

The following functions can be remotely controlled by using a Touch-Tone™ Telephone.

- A. Activating the Entrance Relays.
- B. Latching open the Entrance relays.
- C. Un-latching the Entrance relays.
- D. Opening the microphone and speaker remotely

All factory defaults will be assumed in these examples. If you have changed any of the factory defaults, use your corresponding changes for the examples.

NOTE: IF USING AUTO UNLOCK AND RELOCK, ANY LATCHED FUNCTION WILL NOT BE OVERRIDDEN BY THE SYSTEM CLOCK ENTRANCE GROUP FUNCTION.

REMOTELY ACTIVATING ENTRANCE RELAYS

1. Call the phone number connected to the CAT.
2. After three rings wait for a tone (*). (Default Unit ID Setting.)
3. Press the first digit of the password ("7") and wait for the answer tone (*). After each key press, a beep tone will occur, letting you know that the CAT received (heard) the key you pressed from your phone.
4. Press the second digit of the password ("7") and wait for the acknowledgment tone (*).
5. Press the "*" key and wait for the "password accepted" tone, which is two beeps following the acknowledgment tone (* **). If you make an error, (like an incorrect password) a long error tone (+) will be heard, and the CAT will hang up.
6. Press the Entrance x Open tone, which is Chosen by you. DEFAULT FOR ENTRANCE 1 IS "6".
Press "6". The Entrance 1 relay will energize. If the entrance was latched open, it will relock at the end of the time cycle
7. Press "0" to hang up. The CAT does not hang up automatically. Other relay functions such as timed or latched, speaker/mike open, etc. can be entered, until you press a "0".

REMOTELY LATCHING ENTRANCES RELAYS

1. Get into Remote Control Mode by following above steps 1 through 5.
2. Press the Entrance 1 Latch tone. Since the factory default tone is "0", the CAT will hang up, if a "0" is pressed. A different number other than the Entrance 1 Open tone must be programmed in the Entrance 1 Latch (Section 4.2.2.4) to latch open Entrance 1 control relay and any other entrances.
3. Press "0" to hang up.

REMOTELY UNLATCHING ENTRANCE RELAYS

1. To de-activate remotely a latched relay,
2. Get into Remote Control Mode by following above steps 1 through 6.
3. Step 6 will cause the door to re-lock after Entrance times out.

REMOTELY OPENING MIKE/SPEAKER CHANNEL

NOTE: IF ENTRANCE XX OPEN TONE AND ENTRANCE XX LATCH TONE ARE THE SAME NUMBER, THE ENTRANCE RELAY WILL NOT LATCH OR TIME OUT. IT WILL ENERGIZE BRIEFLY, AND THEN DE-ENERGIZE.

To remotely activate the microphone and speaker:

1. Get into Remote Control Mode by following REMOTELY ACTIVATING ENTRANCE RELAYS Steps 1-5
2. Press the Open Speaker tone. Since the factory default tone is "0", the CAT will hang up, if a "0" is pressed. A different number must be programmed in the Open speaker tone to activate the audio channel..
3. Press "0" to hang up.

CAT Series v 4.1X

4 SETUP AND PROGRAMMING

SETUP AND PROGRAMMING USING THE KEYPAD

After the CAT first powers on, the message "PRESS # TO VIEW DIRECTORY" will appear in the LCD display. The contrast control on the LCD board may have to be adjusted for best contrast, depending on lighting conditions. This adjustment is on the inside door near the top of the door, above the keypad. See the diagram below.

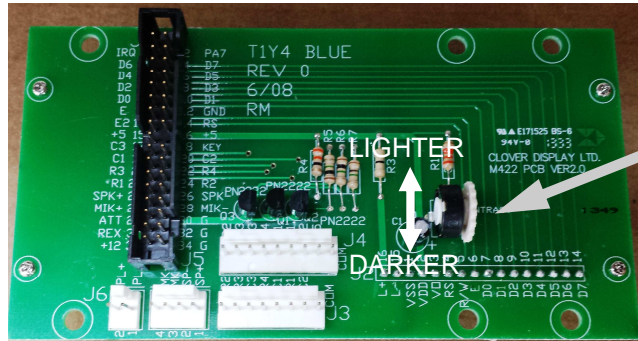

To begin programming press the "*" and the "0" keys simultaneously

PASSWORD _____

« This shows on the display window



After you see this in the window, you have six seconds to start to press the six digit pass code. The factory default pass code is 777777. Each time you press a key, a "*" will appear in the window to keep the pass code confidential. After entering the sixth key, press the "*" key. This should bring you to the main menu. If you don't press a key in any 6 second period, the CAT automatically reverts to operational mode. If during programming, you don't press any key for 60 seconds, the CAT automatically reverts to operational mode.

The choices for the main menu are:

1. CODES / NAMES
2. ENT. CONTROL
3. SYSTEM PARAMETERS
4. COMMUNICATIONS SETUP
5. CLOCK SETUP
6. ACCESS CONTROL
7. BUFFER INFO
8. CLEAR DATA
9. DISPLAY DATA

NOTE:

Newer CATs with lighted key-pads do not have letters on keys. Refer to table on Pg. 30

4 SETUP AND PROGRAMMING

SETUP AND PROGRAMMING USING THE KEYPAD..

MANAGER PASSCODE

The first 3 digits of the 6 digit pass code are for programming main menu choice 1 (CODES/ NAMES) only. This is useful for on site maintenance of names and codes. This prevents the system parameters and configuration from being inadvertently modified after installation.

On the following is an overview of the menu selections possible on a CAT.

PROGRAMMING CHOICES

MAIN MENU

1 = CODES / NAMES

- 1 = ADD / FIND NAME
- 2 = FIND NAME
- 5 = CODES USED
- 6 = SHOW ALL CODES
- 7 = SHOW ALL NAMES
- 8 = ENA ACC GRP = 1
- 9 = ENA SPEC RLY = 1

- FOLLOW MENU
- 1 -6 ALPHA NUMERIC
- DISPLAYS # USED
- CRT ONLY
- CRT ONLY
- ENABLES ACCESS GROUPS
- ENABLES SPECIAL RELAYS

2 = ENT. CONTROL

- SEL ENT 1 - 16
- ENT XX
- 1 = UNLOCK TIME
- 2 = UNLOCK TONE
- 3 = AUTO GROUP
- 4 = LATCH TONE
- 5 = AJAR TIME
- 6 = SPEC RLY ENA = 1
- 7 = OPEN IN PROG

- | SELECT ENTRANCE | Factory Defaults |
|---------------------|------------------|
| 1 -99 SECONDS | 10 |
| 0 -9 T-TONE RECV'D | 6 |
| 0 -7 | 0 |
| 0 - 9 T-TONE RECV'D | 0 |
| 0 - 99 SECONDS | 20 |
| 0-1, (1 = ENABLE) | 0 |
| 0-1, (1 = ENABLE) | 0 |

3 = SYS. PARAMETERS

- | | | |
|-----------------|--------------------------|----|
| 1 = TALK TIME | 1 -99 MINUTES | 01 |
| 2 = ALARM TIME | 1 -99 SECONDS | 10 |
| 3 = CODE LENGTH | 1 -6 DIR LENGTH | 3 |
| 4 = PIN LENGTH | 0 -6 PIN LENGTH | 4 |
| 5 = BACK BEEP | 0-1, (1 = ENABLE) | 0 |
| 6 = TONE DIAL | 0-1, (1 = T-TONE DIAL) | 1 |
| 7 = UNIT ID | 0 -9 RING COUNT | 3 |
| 8 = STRIKE OUT | 0-9, (0 = NO STRIKE-OUT) | 3 |
| 9 = TITLE PAGE | | |

PROGRAMMING CHOICES continued

4 = COMM. SETUP

- 1 = TERMINAL TYPE
- 2 = RS-232 BAUD
- 3 = PROGRAM. PSWD
- 4 = PIN ON ENT = 1
- 5 = SITE CODE
- 6 = DIRECTORY ON =1
- 7 = KEYPAD ON = 0
- 8 = SPKR TONE = 0

	FACTORY DEFAULT
0 - 1, (1 = VT100A)	1
0 - 6, (0=300, 6=19200)	5
1 - 6 DIGITS	777777
1 DIGIT	1
0 - 255	000
0 - 1, (1 = ON)	1
0 - 1, (1 = ON)	0
0 - 9	0

9 = UPDATE LCD (CATVISION ONLY)

5 = CLOCK SETUP

- 1 = SET CLOCK
- 2 = SET TIME ZONES
- 3 = SET HOLIDAYS

6 = ACCESS CONTROL

- 1 = SET GROUPS
- 2 = SET LEVELS
- 3 = NUM RDR MOD

SETS NUM OF EXT READER MODULES

7 = BUFFER INFORMATION

- 1 = VIEW LOG
- 2 = SEND LOG
- 3 = LOG SIZE
- 4 = CLEAR BUFFER

8 = CLEAR DATA

- 1 = SET PARAMETERS
- 2 = CLEAR TIME ZONES
- 3 = CLEAR HOLIDAYS
- 4 = CLEAR AC-LEVELS
- 5 = CLEAR AC-GROUPS
- 6 = CLEAR ENTRANCES
- 7 = CLEAN CODES

9 = DISPLAY DATA

- 1 = SHOW INFO
- 2 = SHOW TIME ZONES
- 3 = SHOW HOLIDAYS
- 4 = SHOW AC-LEVELS
- 5 = SHOW AC-GROUPS
- 6 = SHOW ENTRANCES
- 7 = SHOW ENT BY GROUP
- 8 = SHOW LATCH STATE
- 9 = SHOW MODULE STATE

4 SETUP AND PROGRAMMING

CODES / NAMES

**CODES/NAMES
SELECT 1 - 7**

Pressing "1" (after entering the password) will show the choice at left.

A CODE refers to a record in the CAT's memory. A record consists of:

CODE#	NAME	PHONE	PIN	CARD	ACCESS	GROUP
123	JONES, TIM	555-1212	1234	2760		1

- A. Code numbers can be from 1 to 6 digits.
- B. Names and phone numbers must be entered to display name on directory
- C. Phone numbers can be entered without name, but will not display on directory.
- D. PIN (Personal Identification Number) codes are associated with code numbers.
- E. Optional card numbers (If in use) are associated with code numbers.
- F. Access Groups are associated with code numbers.

ADD / FIND NAME

CODE =

Press "1" on the Codes/Names menu. You will be prompted for the code as shown at left:

If you make a mistake while keying in the code number, press the "0" and the "#" simultaneously to move back one space. From a terminal or computer, press the back arrow key. Enter the code number. It will be between one and six digits depending on the system parameters. After keying in the desired code number, press the "*".

DELETING A CODE

To delete a code number, key in the code number then press "#" followed by "*". This also will erase all data associated with that code number, such as the name, phone number, PIN, and card number.

DELETING A CODE FIELD

To delete a part of a code number, such as a phone number, PIN # or card #, go to that field by pressing the "*" key. When you reach the desired field, key in "0", then "*" from the keypad. This will delete the data in that field, but not any of the other fields associated with the code number.

IF YOU PLACE A "0", IN THE FIRST POSITION OF A NAME FIELD, THEN "#", IT WILL DELETE ALL DATA ASSOCIATED WITH THAT CODE NUMBER.

NAME =

For all CAT models, you will be prompted to enter a name. Names are 1 to 14 characters, including punctuation. It is not necessary to enter a name in a CATCard but you may wish to in order to keep track of card assignments. The keys on the keypad are alphanumeric. Since there are only 12 keys, each key generates it's number, more than one letter, and punctuation.

CAT Series v 4.1X

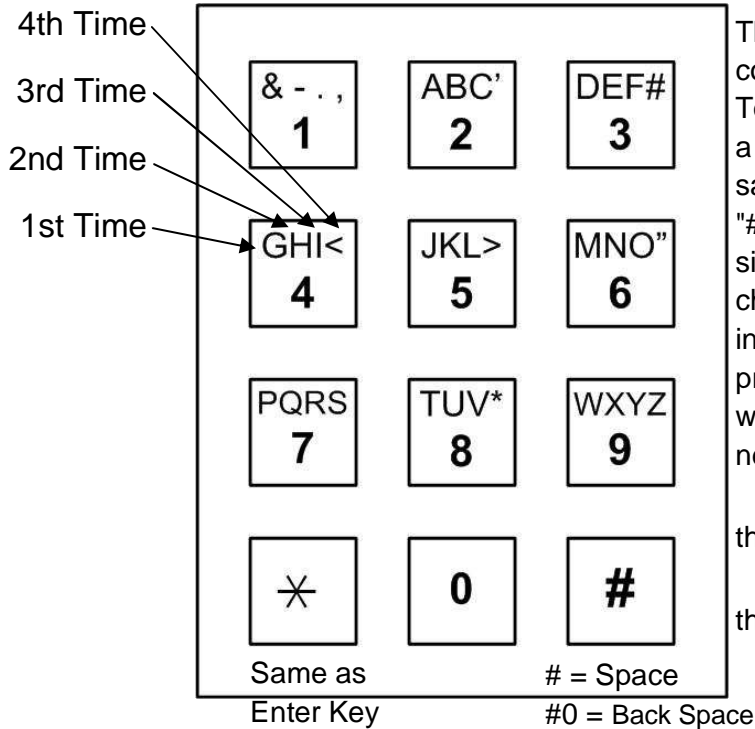

The first time you press a key, the first character corresponding to that key will appear in the display. To get to the second character, press the same key a second time. To get the third character, press the same key a third time. To skip a space, press the "#" key. To backspace, press the "0" and the "#" simultaneously. A backspace over an existing character will delete that character. If you inadvertently key past the desired character, keep pressing the key until the desired character is in the window. Then press the "#" key to advance to the next space. **FOR NUMBERS:**

To select numbers, press the "0" key and then the desired number key.

After completely entering the name, press the "*" key to enter the name into memory.

Refer to this table as a reference for CATs with lighted keypads.

NOTE: PRESS THE # KEY TO MOVE PAST THE LAST LETTER BEFORE PRESSING *, OR LAST LETTER IS NOT PROGRAMMED.

You will be prompted for the phone number. Enter the numbers normally. In this mode, letters are not possible. If you mis-key a digit of the phone number, press the "0" and the "#" simultaneously to backspace and correct the digit. After completely entering the phone number, press the "*" key to enter the phone number into memory. To create a 3 second pause, press the "#" key. For phone systems that dial an 8 or a 9 to get an outside line, key in the number then the "#", then the phone number, then "*".

PHONE # =

HIDE NAME FEATURE: Place a pause as the first item in the phone number (ex. #5551212). The name will not display in the directory, but anyone who dials the code number will still be able to reach the resident. It is not necessary to enter phone numbers in a CATCard but it is allowed for convenience.

You will be prompted to enter a PIN. A PIN is a Personal Identification Number. This will allow anyone who knows this number to enter the facility the CAT controls by entering a "*" and this PIN code. Each name may have a PIN code. The PIN code length is from one to six digits, depending on what you selected from the system parameters menu. All PIN codes must be the same length as what was selected from the system parameters menu. When you enter the PIN code, press the "*" key to place the PIN code into memory. If you disable the PIN (PIN length = 0), this choice will not display.

PIN =

Another selection in this sub-menu is the card reader numbers. The CAT system allows six card numbers per code entry. These are five digit numbers used with the card reader interface. If Facility Site code = 000, this selection may not display. The card numbers for the six cards that will be given to the name or group must be known. Enter these numbers into memory. If you make mistakes while keying in the number, press the "0" and the "#" key pressed simultaneously. This will backspace over the mis-keyed digit. After entering each Card code number, press the "*" key to place the Card code number into memory.

CARD X =

4.2.1.2 FIND NAME**1-6 CHAR. <CR>**

To select the find name function, press "2" from the Codes/Names menu. You will be prompted for 1 - 6 characters. Select characters in the same manner that you programmed names into memory (See the diagram on Pg. 31). When you have entered all desired characters, press "#", then "*".

**CODE = XXX
<CR>MORE**

This message will display whatever code number matches the letters selected. If there is more than one name with similar letters, pressing the "*" key will display additional code numbers that meet the selection criteria.

**NO MATCH
<CR> TO CONT**

If there is no match, you will be prompted to press either the "*" from the keypad, or Enter key from the terminal. A <CR> or "*" will return to sub-menu 1.

SHOW ALL CODES

Select this sub-menu from the Codes/Names menu by pressing "8". This selection will list code numbers and all data associated with code numbers, sorted by CODE NUMBER in ascending order. It sends this data out the optional serial port (OPTKPRT) to a printer or terminal.

SHOW ALL NAMES

Select this sub-menu from the Codes/Names menu by pressing "9". This selection will list code numbers and all data associated with code numbers, sorted by NAMES in ascending order. It sends this data out the optional serial port (OPTKPRT) to a printer or terminal.

ENABLE ACCESS GROUPS**ENA ACC GRP = 0**

Access Groups allow more control of a CAT by adding time zone control and increased card reader control.

To enable Access Groups from the factory default of 0, press "8" from the Codes / Names menu to get this sub-menu. Press "1" to enable Access Groups, and press "*". This will return you to the Codes / Names menu.

ENTRY CONTROL**SEL ENT _**

The Entry Control menu comes with factory defaults that should be sufficient for most installations. These default values are shown on Pg. 28 and 29. Some functions work with options that may not be present on your CAT unit. To get the menu at right, press "2" and then select the entrance to modify. The CAT unit can support up to 16 entrances with options installed.

**ENT XX
SEL FUNCT 1 - 4****ENTRANCE XX UNLOCK TIME****ENT XX
UNLOCK TIME = 10**

Press "1" from the Entry Control menu to set the time in seconds from 1 to 99 seconds. This is the length of time the door control relay for door 1 will be energized. The factory default is 10 seconds. A good rule of thumb for entry time is 3 seconds plus 2 seconds for every step from the CAT to the entrance being controlled. To change time, key in the time desired and press the "*" key. You will be returned to the Entry Control menu.

CAT Series v 4.1X**ENTRANCE XX UNLOCK TONE**

The Entrance XX tone refers to the Touch-Tone™ number from a telephone that must be pressed to energize the door control relay. This relay will be energized for whatever length of time was selected (door open time). Rotary or pulse type telephones must dial any number "6" or greater to energize the door control relay. This will energize only the primary door control relay. To change the number from the default setting of 6 to another number, press "2" from the Entrance 1 Control menu. Select the new number (from 1 -9) and press the "*" key. You will be returned to the Entry Control menu.

**ENT XX UNLOCK
TONE = 6**

NOTE: SELECTING A "0" DISABLES ENTRANCE 1 UNLOCK TONE FEATURE.

ENTRANCE XX AUTO GROUP

The Entrance XX Auto Group refers to the group of Access levels and time zones that allow the entrance to automatically open on given days for the hours that match the time zone programmed.

**ENT XX
AUTO GROUP = 0**

To change the number from the default setting of 0 to another number, press "3" from the ENT 1 Control menu. Select the new number (from 0 - 9) and press the "*" key. You will be returned to the Entry Control menu. **SELECTING A "0" DISABLES THE AUTO GROUP FUNCTION.** Selecting a number from 1 - 9 allows that number to automatically open the door on the days and times set for that group.

**NOTE: AUTOMATIC UNLOCK/RE-LOCK (AUTO GROUP)
OVERRIDES ANY OTHER LATCH CONTROL.**

ENTRANCE XX LATCH TONE

The Entrance X latch tone refers to the touch tone numbers that allow the entrance to automatically latch open when called in remote control mode. To change the number from the default setting of 0 to another number, press "4" from the ENT 1 Control menu. Select the new number (from 0 - 9) and press the "Enter" key. You will be returned to the Entry Control menu. **SELECTING A "0" DISABLES THE LATCH TONE FUNCTION.** Selecting a number from 1 - 9 allows that number to automatically latch open the door for that entrance.

**ENT XX
LATCH TONE = 0**

**NOTE: IF ENT XX TONE AND ENT XX LATCH ARE THE
SAME NUMBER, THE ENT 1 RELAY WILL NOT LATCH
OR TIME OUT. IT WILL ENERGIZE BRIEFLY, AND
THEN DE-ENERGIZE.**

ENTRANCE XX AJAR TIME

Press "5" from the Entry Control menu to set the ajar time. The ajar time is the length of time an entrance may be left ajar before energizing the optional alarm relay. This time is programmable from 1-99 seconds. Default is 0 (Off)

**ENT XX
AJAR TIME = 20**

ENTRANCE XX SPECIAL RELAY ENABLE

Press "1" from the Entry Control menu to enable the auxiliary relays with this entrance. If installed with this CAT system, you may want the the relays to activate with certain entrances only. Default is 0 (Off)

**ENT XX
SPEC RLY ENA = 0**

ENTRANCE XX OPEN IN PROGRAMMING MODE

Press "1" from the Entry Control menu to enable this Entrance to open during programming. During programming, the keypad and card readers are inactive, preventing entry. Setting this entry to One causes this entrance to automatically open during

**ENT XX
OPEN IN PROG = 0**

SYSTEM PARAMETERS**SYS PARAM.**

The System Parameters menu comes with factory defaults that should be sufficient for most installations. These default values are shown on Pg. 28 and 29. Some functions work with options that may not be present on your CAT. For example, selection 2 Alarm Time is not valid unless the optional alarm control relay (OPTK3R) has been purchased. To get the menu at left, press "3" from the main menu.

TALK TIME**TALK TIME = 01**

Talk Time is the time in minutes from 1 - 99 minutes that the CAT remains connected after dial out. In areas of the country where rate usage is a concern, the factory default is 1 minute. For other applications, the talk time can be adjusted upward by pressing "1" from the System Parameters menu to get this sub-menu. Key in the desired number (must be 2 digits) and press "*". This will return you to the System Parameters menu.

ALARM TIME**ALARM TIME = 10**

Alarm time is the time in seconds that the optional alarm relay control (OPTK3R) is energized. To change the alarm time from the factory default of 10 seconds, press "2" from the System Parameters menu to get this sub-menu. Key in the desired number (must be 2 digits) and press "*". This will return you to the System Parameters menu.

CODE LENGTH**CODE LENGTH = 3**

Code length is the number of digits from 1 to 6 entered on the keypad to dial a phone from the CAT. To change the code length from the factory default of 3 digits, press "3" from the System Parameters menu to get this sub-menu. Key in the desired number from 1 - 6 and press "*". This will return you to the System Parameters menu.

PIN LENGTH**PIN LENGTH = 4**

PIN length is the number of digits from 0 to 6, entered from the keypad to enter a PIN code from the CAT. To change the PIN length from the factory default of 4 digits, press "4" from the System Parameters menu to get this sub-menu. Key in the desired number from 0 - 6.

SELECTING PIN LENGTH = "0" DISABLES THE PIN FUNCTION. Press "*" to return to the System Parameters menu.

BACK BEEP**BACK BEEP = 0**

Back Beep is a background tone that will "beep" every 10 seconds when enabled. This allows a called party to determine if someone called from a CAT. To enable the back beep from the factory default of 0, press "5" from the System Parameters menu to get this sub-menu. Press "1" to enable Back Beep, and press "*". This will return you to the System Parameters menu.

CAT Series v 4.1X

TONE DIAL Tone dial selects whether the CAT dials out with Touch-Tones™, or uses pulses, like rotary dial phones. In areas of the country where Touch-Tone™ is not available, tone dial may be disabled. To disable the Tone Dial from the factory default of 1, press "6" from the System Parameters menu to get this sub-menu. Press "0" to disable Tone Dial, and press "*". This will return you to the System Parameters menu.

TONE DIAL = 1**Unit ID or Ring Count**

Unit ID or Ring Count is the number of rings the CAT listens to before it answers. This is useful for the software (Selcom 7) to identify that it is connected to the correct unit and operating the door control relay without being called, or for Remote Programming. If ring count is 0, the CAT will not answer at all. To change the ring count from the factory default of 3 rings, press "7" from the System Parameters menu to get this sub-menu. Key in the desired number from 0 - 9 and press "*". This will return you to the System Parameters menu.

UNIT ID = 3**STRIKE OUT**

Strike Out refers to the number of incorrect PIN code entries that can be made before the CAT "locks up". Once the CAT "locks up", it ignores any key entries for 60 seconds. This is to discourage attempts to guess PIN codes. Select Strike Out from the Door Control menu by pressing "9". To change from the factory default setting of 3, press any key from 0 - 9 and then press "*".

STRIKE OUT = 3

NOTE: IF 0 IS SELECTED, THE CAT WILL PERMIT UNLIMITED ATTEMPTS TO GUESS PIN CODES.

If you enter an invalid PIN code, an error message like the one at right, will display. Wait until the title screen (if selected) appears, or until the error message goes away before re-keying the PIN code. If the number of strike outs is exceeded, an error tone will sound. A message like the one at left, will be shown on the front display of the CAT. If you enter a valid PIN code, the door control relay will energize and the open message shown at right, will display on the CAT for approximately 2 econds and then revert back to the title page.

**INVALID PIN
TRY AGAIN****BUSY PLEASE WAIT****OPEN****TITLE PAGE**

The Title Page has two lines of up to sixteen characters per line, including punctuation. The Title Page can be programmed from the keypad in the same manner as names were programmed.

LINE 1

See the table on the next page for character assignments. The CAT comes with a title page that says "PRESS # TO VIEW DIRECTORY", until the title page is reprogrammed. To program the Title Page from the factory default of "PRESS # TO VIEW DIRECTORY", press "9" from the System Parameters menu to get this sub-menu. Key in the desired character and press "#" to advance to the next character space. Press "#" to advance to a blank space. Press "#" and "0" simultaneously to backspace one character. When the first line is complete, press "*" to advance to the second line.

LINE 2

Continue the second line as required. If you require any modifications of line 2, then line 1 must be re-entered first. After completion, press "*". This will return you to the System Parameters menu.

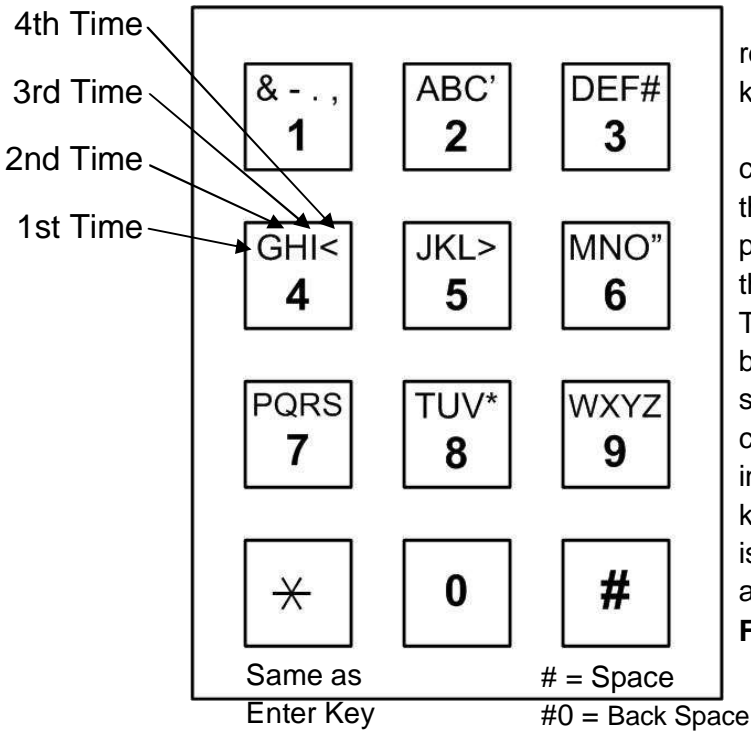

The keypad programming table is repeated here as an aid to selecting the proper key strokes to set the title page.

The first time you press a key, the first character corresponding to that key will appear in the display. To get to the second character, press the same key a second time. To get the third character, press the same key a third time. To skip a space, press the "#" key. To backspace, press the "0" and the "#" simultaneously. A backspace over an existing character will delete that character. If you inadvertently key past the desired character, keep pressing the key until the desired character is in the window. Then press the "#" key to advance to the next space.

FOR NUMBERS:

To select numbers, press the "0" key and then the desired number key. After completely entering the name, press the "*" key to enter the name into memory.

NOTE: PRESS THE # KEY TO MOVE PAST THE LAST LETTER BEFORE PRESSING *, OR LAST LETTER IS NOT PROGRAMMED.

COMMUNICATIONS SETUP

COMM. SETUP

The Communications Setup menu comes with factory defaults that should be sufficient for most installations. These default values are shown on Pg. 28 and 29 . Some functions are used with options that may not be present on your CAT. For example, selection 2 RS-232 Baud is not valid unless you purchase the optional serial printer interface (OPTKPRT). To get the right menu, press "4" from the main menu.

TERMINAL TYPE

TERM. TYPE = 1

The CAT is designed to respond to terminals that follow VT -100B terminal control codes. It also can respond to "dumb terminal" codes. To disable the Terminal Type from the factory default of 1, press "1" from the Communications Setup menu to get this sub-menu. Press "0" to disable VT-100B emulation, and press "*". This will return you to the Communications Setup menu.

CAT Series v 4.1X**RS-232 BAUD**

The RS-232 Baud refers to the rate of speed for serial communications, such as a printer or terminal would need. This function requires the optional printer interface (OPTKPRT). The different rates are:

0 =	300	BAUD
1 =	600	BAUD
2 =	1200	BAUD
3 =	2400	BAUD
4 =	4800	BAUD
5 =	9600	BAUD
6 =	19200	BAUD

Protocol for serial devices is fixed at 8 bits, No parity, 1 stop bit. (8,N,1)

RS-232 BAUD = 5

To change the RS-232 Baud from the factory default of 5, press "2" from the Communications Setup menu to get this sub-menu. Next, select the number corresponding to the desired baud, and press "*". This will return you to the Communications Setup menu.

PROGRAM PASSWORD

The CAT leaves the factory with a default password of 777777. The Password may be alphanumeric (1 - 6 characters) if programmed from an optional terminal. From the front keypad, only numbers (1 - 6 digits) are supported. This provides an additional level of security if you connect a terminal to a CAT. It is possible to create passwords that can not be accessed from the front keypad. To change the Program Password from the factory default of 777777, press "3" from the Communications Setup menu to get this sub-menu. Key in the desired 6 digits for the new password, and press "*". You will be returned to the Communications Setup menu.

PASSWORD = 777777

NOTE: 1st 2 DIGITS OF PROGRAM PASSWORD ARE THE CONTROL PASSWORD, FOR REMOTE CONTROL OF CAT UNIT (SUCH AS ENTRANCE LATCH). 1st 3 DIGITS OF PROGRAM PASSWORD ARE THE MANAGERS PASSWORD THAT ALLOWS ONLY CODE, NAME, PHONE, PIN, CARD, AND GROUP CHANGES.

PIN ON ENTRANCE

This function determines which door control relay is activated when a PIN code (or a Rotary "6" from a called unit) is received by the CAT. To change the number from the default setting of 1 to another number, select "4" from the main menu. Select "4" from this sub-menu. Select the new number (from 1 - 4) and press "*". You will be returned to the COMM. SETUP menu.

PIN ON ENT = 1**SITE CODE**

The Site Code (sometimes called a Facility Code) is used with the Card Readers. Site Code is used to identify the group of cards being used with a particular CAT. This keeps cards on one facility from being used in another facility. The range of Site Codes is from 000 - 255.

To change the Site Code from the factory default of 000, press "5" from the Communications Setup menu to get to this sub-menu. Key in the desired 3 digits corresponding to the Site Code of the cards you have purchased, and press "*".

SITE CODE = 000

NOTE: IF SITE CODE = "000" THE CARD READER FUNCTION IS DISABLED, AND CARD # WILL NOT APPEAR IN CODE/NAMES PROGRAMMING MENU . IF SITE CODE IS SET TO 255, THE SITE CODE ON THE CARD WILL BE IGNORED, AND SECURITY OF CARDS WILL BE REDUCED.

DIRECTORY ON / OFF

DIRECTORY ON=1

This selection allows all directory names to be suppressed from the display. The codes keyed in will still display. All names will still print to the optional printer (OPTKPRT). To disable Directory from the factory default of 1, press "6" from the Communications Setup menu to get this sub-menu. Press "0" to disable Directory, and press "*".

KEYPAD ON / OFF

KEYPAD ON = 0

This selection allows the keypad to remain active after dial out. This is useful for ATM machines, voice mail, and other functions requiring a Touch-Tone™ signal after communications are established. To enable keypad from the factory default of 0, press "7" from the Communications Setup menu to get this sub-menu. Press "1" to enable the keypad, and press "*". Only the number keys are active, * and # will not work. applications, the talk time can be adjusted upward by pressing "1" from the System Parameters menu to get this sub-menu. Key in the desired number (must be 2 digits) and press "*". This will return you to the System Parameters menu.

SPEAKER TONE

SPKR TONE = 0

This selection allows the speaker to be activated for remote control from a telephone in order to listen in. When enabled, the CAT has an open audio channel to permit conversation from someone calling in to the CAT (the microphone is also enabled at the same time). To enable speaker from the factory default of 0 (disabled), press "8" from the Communications Setup menu to get this sub-menu. Select a digit from 1 to 9 to enable speaker, and press "*". This will return you to the Communications Setup menu.

UPDATE LCD (CATVISION ONLY)

UPDATING _

This selection allows information in the CAT memory to be transferred to the display memory. Press 9 to enable update and then press "*". This will return you to the Communications Setup Menu.

CLOCK SETUP

**CLOCK SETUP
SELECT 1 - 3**

- There are three menu choices that are:
1. Set time and date.
 2. Set time zone(s).
 3. Set Holidays.

SETTING TIME / DATE

NOTE: ONCE TIME/DATE PROGRAMMING HAS BEGUN, ALL SELECTIONS MUST BE COMPLETED FOR CHANGES TO TAKE EFFECT.

**00:00 00/00/00
MIN.:**

Select "1" to set the time & date. You will be prompted to enter the current time in minutes as a one or two digit number. If you make a mistake, press "0" and "#" simultaneously to backspace one character. After the minutes are entered, press the "*" key.

**00:00 00/00/00
HOUR:**

Enter a 1 or 2 digit number to set the hour. If a mistake is made, press "0" and "#" simultaneously to backspace one character. After the hour is entered, press the "*" key.

**00:00 00/00/00
DAY, 1..7:**

This is NOT the day of the month. This is a number which corresponds to the day of the week. Enter a number corresponding to the day of the week. Sunday is "1", Saturday is "7" and so forth. If you make a mistake, press "0" and "#" simultaneously to backspace one character. After the day of the week is entered, press the "*" key.

**CAT Series v 4.1X
SETTING TIME / DATE continued**

Enter a 1 or 2 digit number to set the day of the month. If a mistake is made, press "0" and "#" simultaneously to backspace one character. After the day is entered, press the "*" key.

**00:00 00/00/00
DATE:**

Enter a 1 or 2 digit number to set the month. If you make a mistake, press "0" and "#" simultaneously to backspace one character. After the month is entered, press the "*" key.

**00:00 00/00/00
MONTH:**

Enter a 2 digit number to set the year. If you make a mistake, press "0" and "#" simultaneously to backspace one character. After the year is entered, press the "*" key. You will be returned to the Clock Setup menu.

**00:00 00/00/00
YEAR:**

SETTING TIME ZONES

A time zone is a period of time that limits when the CAT is valid. Use this to control access to a facility, when a given condition is valid, based on:

- 1) The time of day.
- 2) The day of the week.
- 3) Whether or not the day of the week is a Holiday.

A time zone is valid only within a 24 hour period that begins at midnight. A time zone has a start time and an ending time. This can be as short as two minutes, or as long as 24 hours. This time period is valid in combinations from 1 to 7 days and Holidays. There are 16 times zones numbered 0 - 15 available for use on a CAT. Not all time zones can be reached from this menu. To access all of them you must use Selcom 7 or newer. Holidays may be set up at any time. A time zone can have valid Holidays, or invalid Holidays. A time zone can be set that is only valid on Holidays, for applications that require different hours of access on Holidays.

From the main menu, select "5" for clock setup, then "2" for time zone.

You will be prompted to select a time zone between 0 and 9. If you make a mistake, press "0" and "#" simultaneously to backspace one character. Once programming of a time zone is begun, all choices must be keyed in or you will be returned to the beginning of the time zone menu.

TIMEZONE <0-9>

After the time zone is selected, press the "*" key. You will be prompted to key in the hour. This is a 1 or 2 digit number. The hour is expressed in 24 hour format (e.g., 2:25 P.M. is keyed in as 14:25), from 00:00 to 23:59. If you make a mistake, press "0" and "#" simultaneously to backspace one character. After the hour is entered, press the "*" Key.

START HOUR 00

You will be prompted to key in the minute. This is a 1 or 2 digit number between 00 and 59. If you make a mistake, press "0" and "#" simultaneously to backspace one character. After the minute is entered, press the "*" key.

START MIN 00

Next, enter the ending hour. This is a 1 or 2 digit number. If you make a mistake, press "0" and "#" simultaneously to backspace one character. After the hour is entered, press the "*" key."0" and "#" simultaneously to backspace one character. After the hour is entered, press the "*" Key.

END HOUR 23

SETTING TIME / DATE continued

END MIN 59

Enter the ending minute. This is a 1 or 2 digit number between 00 and 59. If you make a mistake, press "0" and "#" simultaneously to backspace one character. After the minute is entered, press the "*" key.

DAYS 12345678

Enter the desired day(s). Do this by keying in the number corresponding to the day of the week (1 = Sunday, 7 = Saturday and 8 = Holidays). As an example Monday through Friday would be keyed in as 2, 3, 4, 5 and 6. Days may be entered in any order. If you make a mistake, press "0" and "#" simultaneously to backspace one character. After all days are chosen, press the "*" key.

The table below may be used to help keep track of which Time Zones are required for this installation. Writing them down in the table provided will help reduce programming entry errors.

	Start	Time	Stop	Time		Day	of	the	Week			
Time	Hours	Min.	Hours	Min.	SU	MO	TU	WE	TR	FR	SA	HOL
0												
1												
2												
3												
4												
5												
6												
7												
8												
9												
10												
11												
12												
13												
14												
15												

SETTING HOLIDAYS Holidays can be used to keep time zones valid (or not) on Holidays, or by setting a different time zone to be valid for a different period of time on a Holiday. There are 16 Holidays numbered 0 - 15 available for use on a CAT. Not all holidays can be reached from this menu. Use Selcom 7 or newer to set all the holidays.

Select "3" to set the Holiday. Holidays may be entered in any order.

You will be prompted to select a Holiday between 0 and 9. If you make a mistake, press "0" and "#" simultaneously to backspace one character.

HOLIDAY <0-9>

After the Holiday is selected, you will be prompted to key in the month. This is a 1 or 2 digit number. If you make a mistake, press "0" and "#" simultaneously to backspace one character. Press the "*" key after the month is entered.

MONTH:

After the month is selected, you will be prompted to key in the date. This is a 1 or 2 digit number between 1 and 31. If you make a mistake, press "0" and "#" simultaneously to backspace one character. After the date is entered, press the "*" key.

DATE:

The table below may be used to help keep track of which Holidays are required for this installation. Writing them down in the table provided will help reduce programming entry errors. Remember, Holidays may be entered in any order.

Holiday	Month	Day	Holiday
0			
1			
2			
3			
4			
5			
6			
7			
8			
9			
10			
11			
12			
13			
14			
15			

4 SETUP AND PROGRAMMING

ACCESS CONTROL

Access Control from a CAT is based on four general sets of conditions:

- 1) When a resident (who has been called from a CAT) keys in a valid door tone.
- 2) When a valid PIN code is presented at a door that is valid:
 - a) based on the time of day.
 - b) based on the day of week.
 - c) based on whether the day of the week is a Holiday or not.
- 3) When a valid card number is presented at a door card reader which is valid:
 - a) based on the card reader next to the entrance chosen for access.
 - b) based on the time of day.
 - c) based on the day of week.
 - d) based on whether the day of the week is a Holiday or not.
- 4) When an entrance group is valid, using automatic un-lock and re-lock.

The CAT has many combinations of access control based on these criteria. This versatility can be confusing to an installer, unless the access has been carefully defined BEFORE programming begins. The order in which to plan for an installation should be as follows:

1. Define access area. One entrance, or up to 16?
2. Define time zones.
 - What times is access allowed?
 - For Whom is access allowed? Everybody, or different groups of people?
 - What days is access to be allowed?
 - Are the time zones the same for different days, or different for different days?
 - Are Holidays used, and do Holidays require different time zones?
3. Define Access levels.
 - What time zone is valid for a given access level?
 - Which door is valid for an access level?
 - Is more than one door valid for a time zone?
4. Define Access Groups.
 - What combinations of access levels are in a group?
 - Is the access group to be used for PIN codes and Cards?
 - Is the access group to be used for automatic un-lock and re-lock?

The menu choices in this manual follow the order in which they appear on a CAT. These choices are in reverse order from how a site installation is typically planned. This is to force the installer to decide site requirements before beginning to program the CAT. The CAT was designed this way to help an unwary installer from "programming himself into a corner." There are tables associated with each section. They are there to help with site planning. It is strongly recommended they be completely filled out BEFORE attempting any programming.

ACCESS GROUPS

Access Groups are used to allow groups of individuals card or PIN access by assigning a level or combination of levels to their group. Access Group Zero is predefined as an unlimited group. Group Zero allows access 24 hours a day, ALL days of the year. Access Groups are assigned to the individuals in the Directory. If you do not assign a Group to an individual during the directory entry, Zero (0) is assigned by default.

Since Access Levels have different Time Zone and entrance combinations, this creates many combinations for control of an entrance based on PIN, Card, or time of day.

Once Access Groups are enabled, an Access Group number for a given code number MUST be specified.

The other application for Access Groups is for automatic Unlocking and Relocking Entrances 1 - 4. An Access Group also may be one that has no valid Access Levels when it is needed to prevent entrance access.

From the main menu select "6" for Access

ACCESS CONTROL

SELECTING AN ACCESS GROUP

Select "6" from the main menu. Press the "*" key from the front door key pad, or the Enter key from a terminal. Select "1" from this sub-menu. You will be prompted to select a group from 1 - 9 as shown at right. Press the "*" key from the front door key pad, or the Enter key from a terminal. Not all Groups can be reached from this menu. Use Selcom 7 or newer to set all the Groups.

GROUP 1 - 9

SELECTING AN ACCESS LEVEL

After selecting a group, you will be prompted for levels. These are any combinations from 0 - 9 in any order. To change access levels for a given group, key in the new levels desired and press the "*" key from the front door key pad, or the Enter key from a terminal. To delete access levels entirely use Clear Access Levels. Not all Levels can be reached from this menu. Use Selcom 7 or newer to set all the Levels

LEVELS - - - - -

ACCESS LEVELS

Access Levels are used to attach Time Zones to specific Entrances.

Only one Time Zone is allowed per Access Level. Any combination of entrances may be selected, but at least one entrance must be selected, or the affected Access Level will not function. From one to sixteen entrances may be assigned to an Access Level. Different combinations of control may be created. Do this by assigning one entrance a Time Zone and an Access level, and another entrance the same Time Zone but a different Access Level. Now these Access Levels can be grouped in different combinations for the Access Groups.

PROGRAMMING AN ACCESS LEVEL

Select "6" from the main menu. Press the "*" key from the front door key pad, or the Enter key from a terminal.

Select "2" from this sub-menu. You will be prompted to select a level from 0 - 9 as shown at right. Press the "*" key from the front door key pad, or the Enter key from a terminal. Not all Levels can be reached from this menu. Use Selcom 7 or newer to set all the Levels.

LEVEL <0 - 9>

SELECTING A TIME ZONE

You will be prompted to select a time zone from 0 - 9 as shown at right. Select the desired zone number and press the "*" key from the front door key pad, or the Enter key from a terminal. Not all time zones can be reached from this menu. Use Selcom 7 or newer to set all the time zones.

TIME ZONE <0 - 9>

SELECTING A ENTRANCE

You will be prompted to select a door 1 - 9 as shown at right. Select the desired door combination and press the "*" key from the front door key pad, or the Enter key from a terminal. Your system may not have all of the entrances. Not all entrances can be reached from this menu. Use Selcom 7 or newer to set all the entrances.

ENT. <1 - 9 >
- - - - -

4 SETUP AND PROGRAMMING

SYSTEM PARAMETERS

ACCESS LEVELS continued

Use the table below to help keep track of which Access Levels are required for this installation. Writing them down in the table provided will help reduce programming entry errors.

		ENTRANCE															
ACCESS	TIME																
0																	
1																	
2																	
3																	
4																	
5																	
6																	
7																	
8																	
9																	
10																	
11																	
12																	
13																	
14																	
15																	

AUTOMATIC UNLOCK AND RELOCK BY TIME ZONE

The example on the next page shows how a business might keep two entrances open during peak employee traffic, and secure those two entrances at all other times. Time Zone 1 is valid for one half hour in the morning, Monday through Friday. Time Zone 2 is valid for one half hour in the afternoon, Monday through Friday. Time Zone 0 is valid all the time, except Holidays.

Each Time Zone is assigned to a different Access Level. Both entrances are selected in the Access Levels. The morning and the afternoon Access Levels are grouped together in Access Group 1.

By setting Entrance Group 1 to Access Group 1, the entrance will automatically unlock during peak traffic, and relock at all other times. Employees whose PIN codes or cards are set to Access Level 0, can open the entrance at all other times. If employees try to use their PIN code or Card while the entrances are unlocked, the display on the CAT will show "OPEN".

EXAMPLE OF AN AUTOMATIC UNLOCK APPLICATION

Time Zone Setting

Time	Start Time		Stop Time		Day of the Wee							
	Hour	Min.	Hour	Min.								
0												
1	07	45	08	15		X	X	X	X	X		
2	16	45	17	15		X	X	X	X	X		

Access Level Setting

AL1 (USES TIME ZONE 1 MORNING HOURS M - F)

AL2 (USES TIME ZONE 2 AFTERNOON HOURS M - F)

AG1 (USES ACCESS LEVELS 1 AND 2)

THEN USE AG1 TO AUTO UNLOCK ENTR. 1 AND ENTR. 2

ENTRANCE				
ACCESS TIME				
0				
1	1	X	X	
2	2	X	X	

Access Levels		
ACCESS		
0	Always Active	Always Active
1	X	X
2		

These are shorter versions of the other tables in this manual. Start by defining which entrance is to be unlocked, for how long, on which days. This is the time zone data. Next, define which combinations of doors are controlled by a time zone. This is an access level. Last, group access levels into an access group. The Entrance Group is that access group number.

TRANSACTION BUFFER INFORMATION

The transaction buffer stores any event that would normally create a logging printer message. For examples of report messages, see Pg. 18 or 66. The size of the transaction buffer depends on the capacity of the CAT. Usually, the smaller the capacity the larger the transaction buffer space. After a transaction buffer becomes full, it begins to overwrite the oldest event in the transaction buffer storage space.

Press "7" from the main menu to get the selection shown at right. Press "*" to return to the Main menu

BUFFER INFO.

4 SETUP AND PROGRAMMING

TRANSACTION BUFFER INFORMATION continued

VIEW LOG

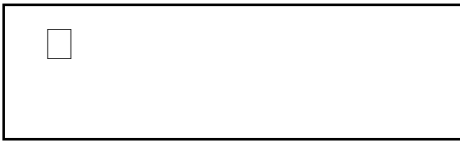

This allows the log to be viewed from a terminal connected to the optional serial port. The log also may be viewed from a personal computer communicating through the optional modem. Pressing "1" from the front panel keypad will only show a cursor box in the LCD display as shown at left. The CAT will sound a long error beep and return to the Buffer Information menu.

SEND LOG



Pressing "2" will send all logging data to either the optional serial port or to the optional modem, if you are using a terminal through the modem.. A message like the one at left will display.

BUFFER INFO

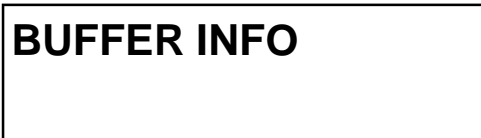

After all data stored in the buffer has been sent, the message shown at left will display. Press "*" to return to the Buffer Information menu. Press "*" again, to return to the Main menu.

TRANSACTION BUFFER FREE



Pressing "3" from the front panel keypad will only show the approximate amount of space remaining in the buffer A message similar to left will appear

SEND LOG



Press "4" to get to the menu at left. Pressing a "1" then "*" clears all transactions stored in the buffer for the CAT. If you press a "1" by mistake, press "#" and "0" simultaneously to backspace over the "1". Press "0" then "*" to return to the main menu. If you press any key other than "1", the CAT will sound a long error beep. Press "*" to return to the Buffer Information menu. Press "*" again, to return to the Main menu.

CLEAR DATA



SET PARAMETERS

Pressing "1" returns all Entrance Control, System Parameters and Communication Setup settings to the SES factory defaults. These defaults are shown on Pg. 28 and 29. Press "1" to reset the parameters

CLEAR TIME ZONES

Pressing "2" causes this selection to clear any previously programmed time zone and resets all times to 00:00. Press "1" to Clear, "0" to Abort. Press "*" to return to the Main menu.

CLEAR HOLIDAYS

Pressing "3" causes this selection to clear all Holidays from memory. This is useful for Holidays that are observed on different days from year to year, such as Thanksgiving or Labor Day. Press "1" to Clear, "0" to Abort. Press "*" to return to the Main menu.

CLEAR ACCESS LEVELS

Pressing "4" causes this selection to clear all access levels of any previously programmed data. Press "1" to Clear, "0" to Abort. Press "*" to return to the Main menu.

CLEAR ACCESS GROUPS

Pressing "5" causes this selection to clear all access groups of any previously programmed data. Press "1" to Clear, "0" to Abort. Press "*" to return to the Main menu.

CLEAR ENTRANCES

Pressing "6" causes this selection to clear all entrance data. Press "1" to Clear, "0" to Abort. Press "*" to return to the Main menu.

CLEAN DIRECTORY CODES

Pressing "7" causes this selection to clean the corrupted directory codes. Press "1" to Clear, "0" to Abort. Press "*" to return to the Main menu.

DISPLAY DATA

Pressing the menu election "9" is used with an optional printer (OPTPRT), or a CRT or terminal for sub-menu choices 1 through 5. Data is sent to the optional serial port. It is used to print various parameters, such as Time Zones, Holidays, Access Levels, Access Groups and general Information. Sub-menu choices 6 through 9 send data to the LCD display on the front panel of the CAT. To select this function, press "9" from the Main Menu. You will see the display,

**DISPLAY DATA
SELECT 1 - 1**

Pressing selection "1" will cause the display at right, to be shown briefly.

**PRINTING BUSY
PLEASE WAIT**

Next, this message will be shown. Press "*" to return to the sub-menu and print out other information

SHOW INFO

Pressing "1" will send the system configuration information (like the example below) for this CAT to a CRT or printer.

VER 4.19XX 2R
CODE CAP = 0110
PHONE CAP = 0100
UNIT ID = 3
CODE LENGTH = 3
PIN LENGTH = 4
SITE CODE = 010
CR BIT TYPE = 0
NUM RDR MOD = 2
DISP TYPE = 2
ENA ACC GRP = 0
PRESS # TO VIEW
DIRECTORY
PASSWORD = 777777

SHOW TIME ZONES

Pressing "2" will send Time Zones to a CRT or printer.

ZONE	STIME	ETIME	SMTWTFSH
00	00:00	00:00	-----
01	00:00	00:00	-----
02	00:00	00:00	----- (TZ 3 –13 Typical)
14	00:00	00:00	-----
15	00:00	00:00	-----

4 SETUP AND PROGRAMMING

SHOW HOLIDAYS

Pressing "3" will send holidays to a CRT or printer.

HOL	MONTH	DATE
00	00	00
01	00	00
02	00	00
03	00	00
04	00	00
05	00	00
06	00	00
07	00	00
08	00	00
09	00	00
10	00	00
11	00	00
12	00	00
13	00	00
14	00	00
15	00	00

SHOW ACCESS LEVELS

Pressing "4" will send all Access Levels to a CRT or printer.

LEVEL	ENTRANCE	TZ	STIME	ETIME	SMTWTFSH
00	123456789012345	00	00:00	23:59	1234567-
01	12—67—1-345	01	07:45	08:30	-23456---
02	1-3—————	02	16:30	17:15	-23456---
03	-23—————	00	00:00	23:59	1234567-
04	-----	00	00:00	23:59	1234567-
05	-----	00	00:00	23:59	1234567-
06	-----	00	00:00	23:59	1234567-
07	-----	00	00:00	23:59	1234567-
08	123—————	00	00:00	23:59	1234567-
09	12—————	01	07:45	08:30	-23456---
10	1-3—————	02	16:30	17:15	-23456---
11	-23—————	00	00:00	23:59	1234567-
12	-----	00	00:00	23:59	1234567-
13	-----	00	00:00	23:59	1234567-
14	-----	00	00:00	23:59	1234567-
15	-----	00	00:00	23:59	1234567-

SHOW ACCESS GROUPS

Pressing "5" will send Access Groups (4.2.9.5) to a CRT or printer. In this example, 3 Access Groups of the possible total of 16, are shown.

AG	AL	ENTRANCE	TZ	STIME	ETIME	SMTWTFSH
01	01	12-456789012345	01	07:45	08:30	-23456--
02	02	123—67—1-345	02	16:30	17:15	-23456--
03	00	-23—————	00	00:00	23:59	1234567-

SHOW ENTRANCES

Pressing "6" displays the entrances information on the LCD display located on the front panel of the CAT. When first selected, the display will show:

ENT NO	OPEN TIME	OPEN TONE	AUTO GROUP	LATCH TONE	AJAR TIME	SPEC RLY	OPEN PROG
01	10	6	00	0	20	0	0
16	10	0	00	0	20	0	0

(Entrances 2-16 Typical)

Press "*" to return to the Display Data menu.

SHOW ENTRANCES BY GROUP

Pressing "7" displays the Group information on the LCD display located on the front panel of the CAT. When first selected, the display will show qny active entrances by group.

Press "*" to return to the Display Data menu.

SHOW LATCH BY STATE

Pressing "8" displays the Latch State information by Entrance and whether it was latched by Time Zone (T) Program mode (P) or Command ©

ENT	T	P	C
01		1	
16	1		

(Entrances 2-16 Typical)

Press "*" to return to the Display Data menu.

SHOW MODULE STATE

Pressing "9" displays Module State for any CR-4 Reader Modules attached to the CAT. It shows each of the three addresses (1, 2, 3) and a 0 or a 1 to show whether there is a module present.

MOD	STATE
1	1
2	0
3	0

In this example only 1 DR-4 is attached to the CAT.

Press "*" to return to the Display Data menu.

USING A TERMINAL TO PROGRAM

It is occasionally necessary to directly program CAT / TEC units' memory. The following example uses SES's Program SELCOM 7 or newer as an example. To use other terminal programs, consult their manual for setup and use. Using Selcom 7 or newer, proceed with the following.

- 1) Select the desired site.
- 2) Click on Menu Driven Direct.
- 3) Click on Connect icon.

If connecting with a serial connection, you must press the [ESC] key for the unit to prompt you for the password. If you do not press [ESC], the unit will send transaction data to the terminal as it occurs.

If connecting with a modem, Selcom 7 or newer will call the CAT unit and prompt you for the password by changing the screen from white to black and prompting with the word PASSWORD_ This is the programming password found in your System CFG menu. Key in the 6 digit password and press "Enter" You should get a selection that says Main Menu and has 9 selections available.

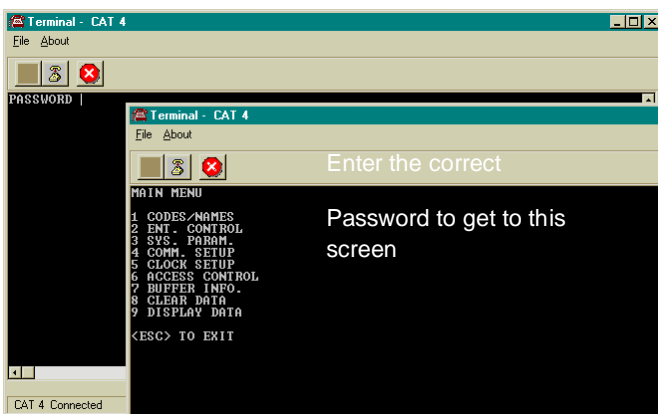

If you make a mistake at any time, before pressing the <Enter> key you can correct it by using the <Backspace> or <BkSp> key. This will depend on what it is called on your keyboard.

<< This shows on the display window first with a modem or after pressing <Esc> using a serial connection.

<< This shows after entering the correct password window

After you see this in the window, you have six seconds to start to press the six digit pass code. The factory default pass code is 777777. Each time you press a key, a "*" will appear in the window to keep the pass code confidential. After entering the sixth key, press the <Enter> key. This should bring you to the main menu. If you don't press a key in any 6 second period, the CAT automatically reverts to operational mode. If during programming, you don't press any key for 60 seconds, the CAT automatically reverts to operational mode.

The choices for the main menu are:

- | | |
|-------------------------|--|
| 1. CODES / NAMES | Change Directory items (Codes, Names, Card No's, Phone No's) |
| 2. ENT. CONTROL | Setup Entrance Timing, Open Tones, Latch Tones, etc. |
| 3. SYSTEM PARAMETERS | Change Title Page Text, Talk Time, PIN Length, Unit ID, etc. |
| 4. COMMUNICATIONS SETUP | Modify Baud Rate, Site Code, Password, PIN Entrance, etc.. |
| 5. CLOCK SETUP | Check Internal Clock Time/Date, Holidays, Time Zones, etc.. |
| 6. ACCESS CONTROL | Setup Access Groups, Levels, External Readers |
| 7. BUFFER INFO | View and Erase Transaction Log Buffer |
| 8. CLEAR DATA | Erase Holidays, Time Zones, Reset Entrance Timing, etc... |
| 9. DISPLAY DATA | Examine System, Access Control and Entrance Parameters, etc. |

The nine choices above may have from 1 to 9 additional choices in a particular category. After you make a menu selection and completed the task or want to return, pressing the <Enter> key will return to the main menu.

To examine the complete Menu structure continue to the next page.

To see how to use the Codes/Names (Directory) Menu go to page 54

To use the terminal to change operating parameters, go to page 57

MANAGER PASSCODE

The first 3 digits of the 6 digit pass code are for programming main menu choice 1 (CODES/ NAMES) only. This is useful for on site maintenance of names and codes. This prevents the system parameters and configuration from being inadvertently modified after installation.

On the following is an overview of the menu selections possible on a CAT.

PROGRAMMING CHOICES

MAIN MENU

1 = CODES / NAMES

- 1 = ADD / FIND NAME
- 2 = FIND NAME
- 3 = FIND PIN
- 4 = FIND CARD
- 5 = CODES USED
- 6 = SHOW ALL CODES
- 7 = SHOW ALL NAMES
- 8 = ENA ACC GRP = 1
- 9 = ENA SPEC RLY = 1

- FOLLOW MENU
- 1 -6 ALPHA NUMERIC
- FINDS PIN
- FINDS CARD
- DISPLAYS # USED
- CRT ONLY
- CRT ONLY
- ENABLES ACCESS GROUPS
- ENABLES SPECIAL RELAYS

2 = ENT. CONTROL

- SEL ENT 1 - 16
- ENT XX
- 1 = UNLOCK TIME
- 2 = UNLOCK TONE
- 3 = AUTO GROUP
- 4 = LATCH TONE
- 5 = AJAR TIME
- 6 = SPEC RLY ENA
- 7 = OPEN IN PROG

- SELECT ENTRANCE
- 1 -99 SECONDS 10
- 0 -9 T-TONE RECV'D 6
- 0 -7 0
- 0 - 9 T-TONE RECV'D 0
- 0 - 99 SECONDS 20
- 0-1, (1 = ENABLE) 0
- 0-1, (1 = ENABLE) 0

**FACTORY
DEFAULTS**

3 = SYS. PARAMETERS

- 1 = TALK TIME
- 2 = ALARM TIME
- 3 = CODE LENGTH
- 4 = PIN LENGTH
- 5 = BACK BEEP
- 6 = TONE DIAL
- 7 = UNIT ID
- 8 = STRIKE OUT
- 9 = TITLE PAGE

- 1 -99 MINUTES 01
- 1 -99 SECONDS 10
- 1 -6 DIR LENGTH 3
- 0 -6 PIN LENGTH 4
- 0-1, (1 = ENABLE) 0
- 0-1, (1 = T-TONE DIAL) 1
- 0 -9 3
- 0-9, (0 = NO STRIKE-OUT) 3

PROGRAMMING CHOICES continued

4 = COMM. SETUP

- 1 = TERMINAL TYPE
- 2 = RS-232 BAUD
- 3 = PROGRAM. PSWD
- 4 = PIN ON ENT = 1
- 5 = SITE CODE = 000
- 6 = DIRECTORY ON =1
- 7 = KEYPAD ON = 0
- 8 = SPKR TONE = 0

	FACTORY DEFAULT
0 - 1, (1 = VT100A)	1
0 - 6, (0=300, 6=19200)	5
1 - 6 DIGITS	777777
1 DIGIT	1
0 - 255	000
0 - 1, (1 = ON)	1
0 - 1, (1 = ON)	0
0 - 9	0

9 = UPDATE LCD (CATVISION ONLY)

5 = CLOCK SETUP

- 1 = SET CLOCK
- 2 = SET TIME ZONES
- 3 = SET HOLIDAYS

6 = ACCESS CONTROL

- 1 = SET GROUPS
- 2 = SET LEVELS
- 3 = NUM RDR MOD

SETS NUM OF EXT READER MODULES

7 = BUFFER INFORMATION

- 1 = VIEW LOG
- 2 = SEND LOG
- 3 = LOG SIZE
- 4 = CLEAR BUFFER

8 = CLEAR DATA

- 1 = SET PARAMETERS
- 2 = CLEAR TIME ZONES
- 3 = CLEAR HOLIDAYS
- 4 = CLEAR AC-LEVELS
- 5 = CLEAR AC-GROUPS
- 6 = CLEAR ENTRANCES
- 7 = CLEAN CODES

9 = DISPLAY DATA

- 1 = SHOW INFO
- 2 = SHOW TIME ZONES
- 3 = SHOW HOLIDAYS
- 4 = SHOW AC-LEVELS
- 5 = SHOW AC-GROUPS
- 6 = SHOW ENTRANCES
- 7 = SHOW ENT BY GROUP
- 8 = SHOW LATCH STATE
- 9 = SHOW MODULE STATE

CODES / NAMES

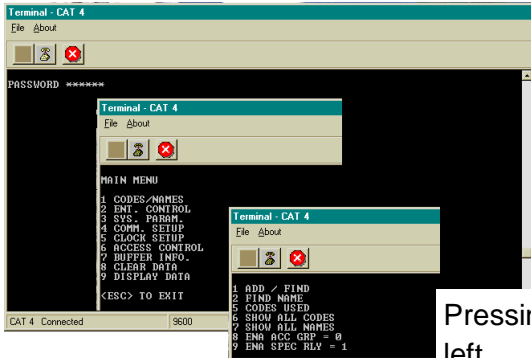

Pressing "1" (after entering the password) will show the choice at left.

ADD / FIND NAME

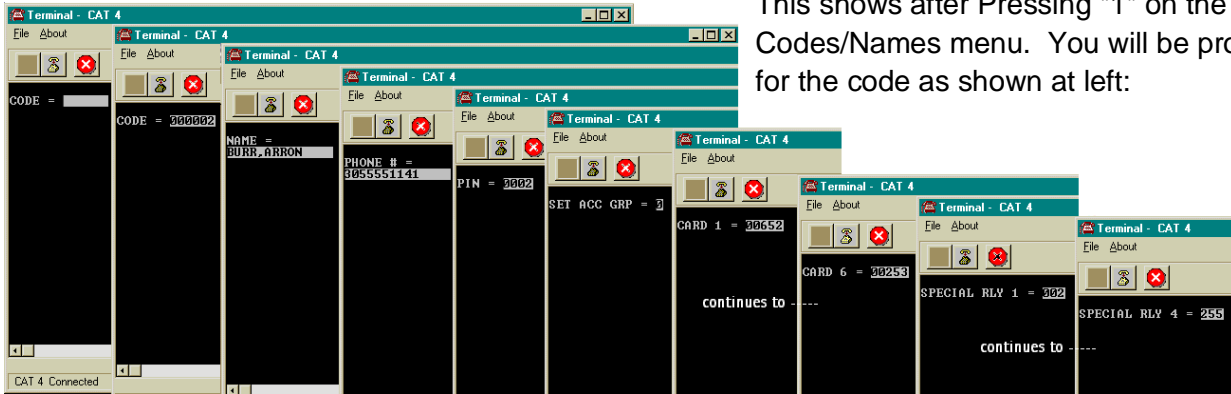

This shows after Pressing "1" on the Codes/Names menu. You will be prompted for the code as shown at left:

To delete a code number, key in the code number then press the "DEL" (delete key) followed by the "Enter" key.

To delete a part of a code number, such as a phone number, PIN # or card #, go to that field by pressing the "Enter". When you reach the desired field, key in "0", and then the "Enter" key. This will delete the data in that field, but not any of the other fields associated with the code number.

IF YOU TYPE ANY CHARACTER, IN THE FIRST POSITION OF A NAME FIELD, IT WILL DELETE ALL DATA ASSOCIATED WITH THAT CODE NUMBER.

PHONE # =: You will be prompted for the phone number. Enter the numbers normally. For this field, letters are not possible. Press the ":" key to generate a 3 second pause.

HIDE NAME FEATURE: Place a pause as the first item in the phone number (ex. :5551212). The name will not display in the directory, but anyone who dials the code number will still be able to reach the resident. It is not necessary to enter phone numbers in a Cat Card but it is allowed for convenience.

PIN =: You will be prompted to enter a PIN. A PIN is a Personal Identification Number. This will allow anyone who knows this number to use the PIN entrance by entering a "*" and this PIN code. Each name may have a PIN code. The PIN code length is from one to six digits, depending on what you selected from the system parameters menu All PIN codes must be the same length as what was selected from the system parameters menu. Enter the PIN code, and then the "Enter" to place the PIN code into memory. If you disable the PIN (PIN length = 0), this choice will not display.

CARD X =: Another selection in this sub-menu is the card reader numbers. The CAT system allows six card numbers per code entry. These are five digit numbers used with the card reader interface. If Facility Site code = 000, this selection may not display.

The card numbers for the six cards that will be given to the name or group must be known. Enter these numbers into memory. If you make mistakes while keying in the number, press the back arrow. This will backspace over the mis-keyed digit. After entering each Card code number, press the "Enter" or * key to place the Card code number into memory.

SPEC RLY X =: The last selection in this sub-menu is the special relay numbers. The CAT system allows four external relays to be activated per code entry. These are three digit numbers used with the card reader interface. If Facility Site code = 000, this selection may not display.

The card numbers for the six cards that will be given to the name or group must be known. Enter these numbers into memory. If you make mistakes while keying in the number, press the back arrow. This will backspace over the mis-keyed digit. After entering each Card code number, press the "Enter" key to place the Card code number into memory.

FIND NAME

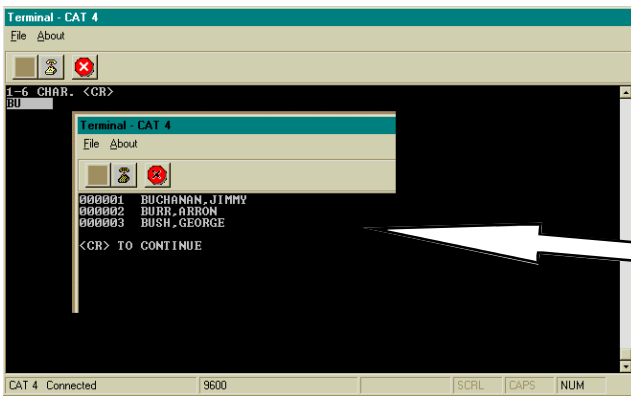

To select the find name function, press "2" from the Codes/Names menu. You will be prompted for 1 - 6 characters. Select characters in the same manner that you programmed names into memory. When you have entered all desired characters, press the "Enter" key.

This message will display whatever code number matches the letters selected. If there is more than one name with similar letters, pressing the "Enter" key will display additional code numbers that meet the selection criteria.

If there is no match, you will be prompted to press "Enter" or * key from the terminal. Pressing the "Enter" key will return to sub-menu 1 (See section on Codes / Names).

SHOW ALL CODES

SHOW ALL NAMES

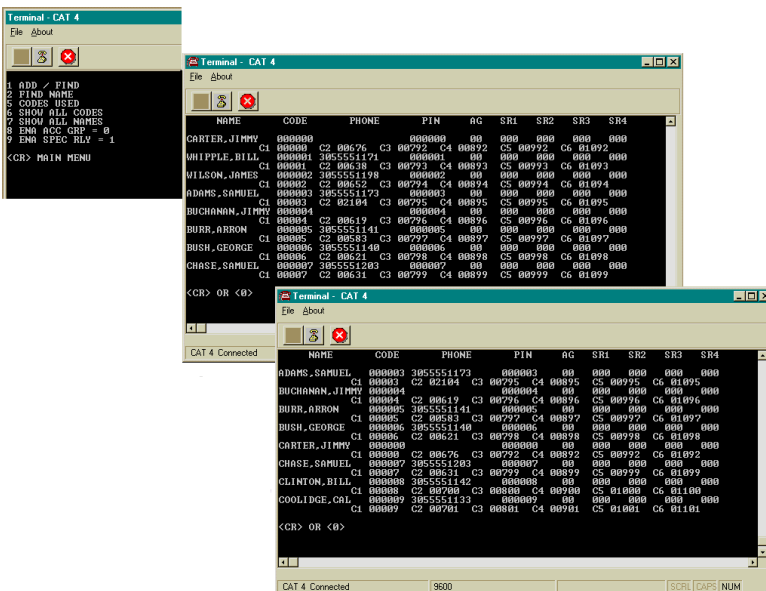

Codes: Select this sub-menu from the Codes/Names menu by pressing "8". This selection will list code numbers and all data associated with code numbers, sorted by CODE NUMBER in ascending order. It sends this data out to the computer screen.

Names: Select this sub-menu from the Codes/Names menu by pressing "9". This selection will list code numbers and all data associated with code numbers, sorted by NAMES in ascending order. It sends this data out to the computer screen.

ENABLE ACCESS GROUPS

ENA ACC GRP = 0

Access Groups allow more control of a CAT by adding time zone control and increased card reader control. To enable Access Groups from the factory default of 0, press "8" from the Codes / Names menu to get this sub-menu. Press "1" to enable Access Groups, and press the "Enter" key. This will return you to the Codes / Names menu.

ENA SPEC RLY =

Special Relay option allows more control with a CAT by adding external relay control and adds four relay numbers to each directory entry.

To enable Spec Rly from the factory default of 0, press "9" from the Codes / Names menu to get this sub-menu. Press "1" to enable Spec Rly, and press the "Enter" key. This will return you to the Codes / Names menu.

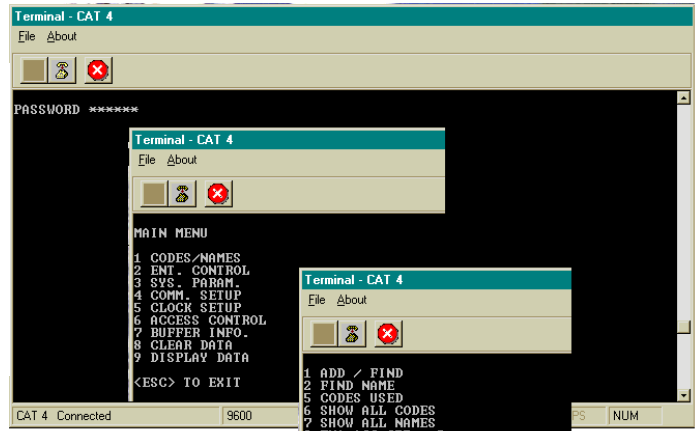

ENTRY CONTROL

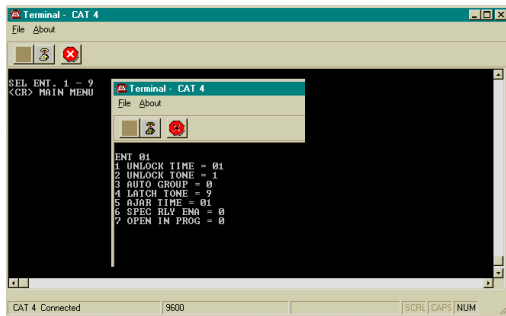

The Entry Control menu comes with factory defaults that should be sufficient for most installations. These default values are shown on Pg. 51 and 52 . Some functions work with options that may not be present on your CAT unit. To get the menu at left, press "2" and then select the entrance to modify, The CAT unit can support up to 16 entrances with options installed.

ENTRANCE XX UNLOCK TIME

Press "1" from the Entry Control menu to set the time in seconds from 1 to 99 seconds. This is the length of time the door control relay for door 1 will be energized. The factory default is 10 seconds. A good rule of thumb for entry time is 3 seconds plus 2 seconds for every step from the CAT to the entrance being controlled. To change time, key in the time desired and press the "Enter" key. You will be returned to the Entry Control menu.

ENTRANCE XX UNLOCK TONE

The Entrance XX tone refers to the Touch-Tone™ number from a telephone that must be pressed to energize the door control relay. This relay will be energized for whatever length of time was selected. Rotary or pulse type telephones must dial any number "6" or greater to energize the door control relay. This will energize only the primary door control relay. To change the number from the default setting of 6 to another number, press "2" from the Entrance 1 Control menu. Select the new number (from 1 - 9) and press the "Enter" key. You will be returned to the Entry Control menu.

NOTE: SELECTING A "0" DISABLES ENTRANCE XX UNLOCK TONE FEATURE.

ENTRANCE XX AUTO GROUP

The Entrance XX Auto Group refers to the group of Access levels and time zones that allow the entrance to automatically open on given days for the hours that match the time zone programmed. . To change the number from the default setting of 0 to another number, press "3" from the ENT 1 Control menu. Select the new number (from 0 - 9) and press the "Enter" key. You will be returned to the Entry Control menu. **SELECTING A "0" DISABLES THE AUTO GROUP FUNCTION.** Selecting a number from 1 - 9 allows that number to automatically open the door on the days and times set for that group.

5 TERMINAL PROGRAMMING

ENTRANCE XX LATCH TONE

The Entrance XX Auto Group refers to the group of Access levels and time zones that allow the entrance to automatically open on given days for the hours that match the time zone programmed. To change the number from the default setting of 0 to another number, press "3" from the ENT 1 Control menu. Select the new number (from 0 - 9) and press the "Enter" key. You will be returned to the Entry Control menu. SELECTING A "0" DISABLES THE AUTO GROUP FUNCTION. Selecting a number from 1 - 9 allows that number to automatically open the door on the days and times set for that group.

NOTE: IF ENT XX TONE AND ENT XX LATCH ARE THE SAME NUMBER, THE ENT 1 RELAY WILL NOT LATCH OR TIME OUT. IT WILL ENERGIZE BRIEFLY, AND THEN DE-ENERGIZE.

ENTRANCE XX AJAR TIME

Press "5" from the Entry Control menu to set the time the entrance may be left ajar before energizing the optional alarm relay. Present with 2 Entrance units installed with this CAT system. Also in the first two entrances in a four entrance system when the alarm function is turned off by setting alarm time to zero. Default is 0 (Off)

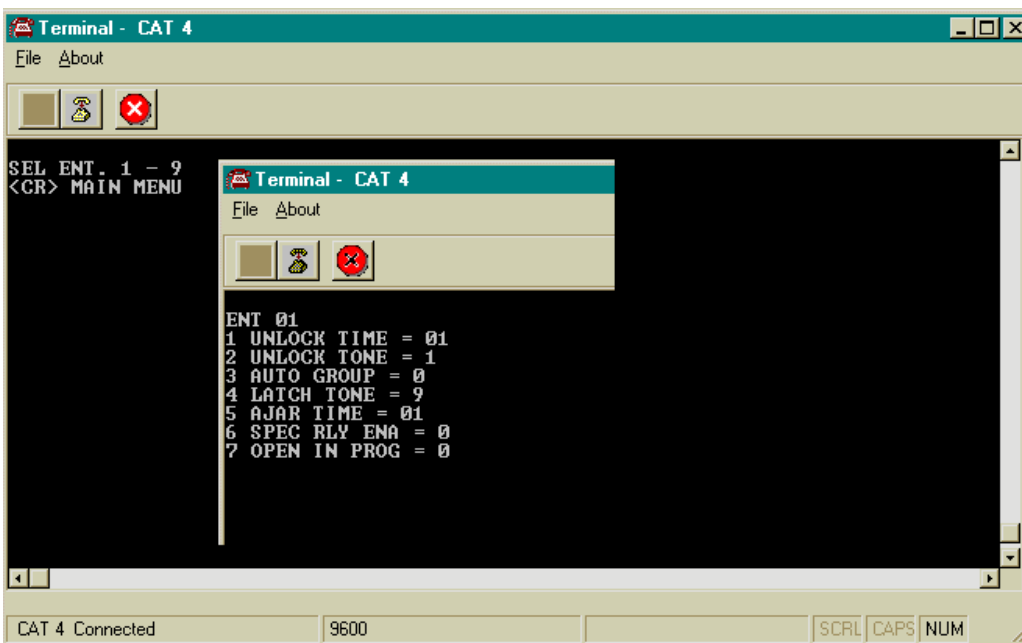

ENTRANCE XX SPECIAL RELAY ENABLE

Press "1" from the Entry Control menu to enable the auxiliary relays with this entrance. If installed with this CAT system, you may want the the relays to activate with certain entrances only. Default is 0 (Off)

ENTRANCE XX OPEN IN PROGRAMMING MODE

Press "1" from the Entry Control menu to enable this Entrance to open during programming. During programming, the keypad and card readers are inactive, preventing entry. Setting this entry to One causes this entrance to automatically open during programming.

SYSTEM PARAMETERS

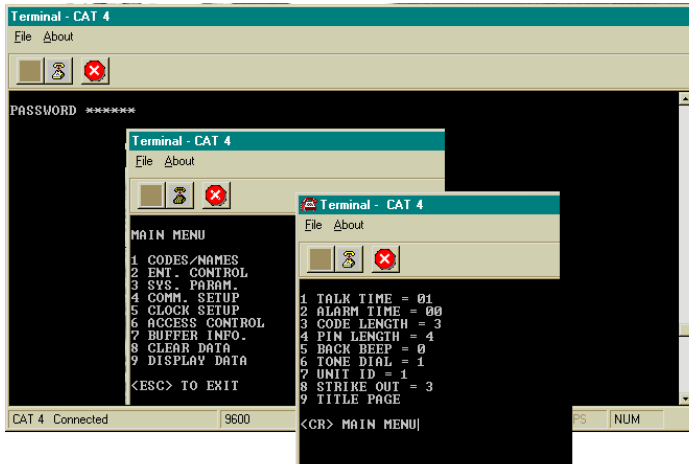

The System Parameters menu comes with factory defaults that should be sufficient for most installations. These default values are shown on Pg. 51 and 52. Some functions work with options that may not be present on your CAT. For example, selection 2 Alarm Time is not valid unless the optional alarm control relay (OPTK3R) has been purchased. To get the menu at left, press "3" from the main menu.

TALK TIME

Talk Time is the time in minutes from 1 - 99 minutes that the CAT remains connected after dial out. In areas of the country where rate usage is a concern, the factory default is 1 minute. For other applications, the talk time can be adjusted upward by pressing "1" from the System Parameters menu to get this sub-menu. Key in the desired number (must be 2 digits) and press "Enter" key. This will return you to the System Parameters menu.

ALARM TIME

Alarm time is the time in seconds that the optional alarm relay control (OPTK3R) is energized. To change the alarm time from the factory default of 10 seconds, press "2" from the System Parameters menu to get this sub-menu. Key in the desired number (must be 2 digits) and press "Enter" key. This will return you to the System Parameters menu.

CODE LENGTH

Code length is the number of digits from 1 to 6 entered on the keypad to dial a phone from the CAT. To change the code length from the factory default of 3 digits, press "3" from the System Parameters menu to get this sub-menu. Key in the desired number from 1 - 6 and press "Enter" key. This will return you to the System Parameters menu.

PIN LENGTH

PIN length is the number of digits from 0 to 6, entered from the keypad to enter a PIN code from the CAT. To change the PIN length from the factory default of 4 digits, press "4" from the System Parameters menu to get this sub-menu. Key in the desired number from 0 - 6. SELECTING PIN LENGTH = "0" DISABLES THE PIN FUNCTION. Press "Enter" key to return to the System Parameters menu.

BACK BEEP

Back Beep is a background tone that will "beep" every 10 seconds when enabled. This allows a called party to determine if someone called from a CAT. To enable the back beep from the factory default of 0, press "5" from the System Parameters menu to get this sub-menu. Press "1" to enable Back Beep, and press "Enter" key. This will return you to the System Parameters menu.

TONE DIAL

Tone dial selects whether the CAT dials out with Touch-Tones™, or uses pulses, like rotary dial phones. In areas of the country where Touch-Tone™ is not available, tone dial may be disabled. To disable the Tone Dial from the factory default of 1, press "6" from the System Parameters menu to get this sub-menu. Press "0" to disable Tone Dial, and press "Enter" key. This will return you to the System Parameters menu.

Unit ID or Ring Count

Unit ID or Ring Count is the number of rings the CAT listens to before it answers. This is useful for the software (Selcom 7 or newer) to identify that it is connected to the correct unit and operating the door control relay without being called, or for Remote Programming. If ring count is 0, the CAT will not answer at all. To change the ring count from the factory default of 3 rings, press "7" from the System Parameters menu to get this sub-menu. Key in the desired number from 0 - 9 and press "Enter" key. This will return you to the System Parameters menu.

STRIKE OUT

Strike Out refers to the number of incorrect PIN code entries that can be made before the CAT "locks up". Once the CAT "locks up", it ignores any key entries for 60 seconds. This is to discourage attempts to guess PIN codes. Select Strike Out from the Door Control menu by pressing "9". To change from the factory default setting of 3, press any key from 0 - 9 and then press "Enter" key.

NOTE: IF 0 IS SELECTED, THE TEC WILL PERMIT UNLIMITED ATTEMPTS TO GUESS PIN CODES.

If you enter an invalid PIN code, an error message like the one at right, will display. Wait until the title screen (if selected) appears, or until the error message goes away before re-keying the PIN code.

**INVALID PIN
TRY AGAIN**

If the number of strike outs is exceeded, an error tone will sound. A message like the one at right, will be shown on the front display of the CAT.

BUSY PLEASE WAIT

If you enter a valid PIN code, the door control relay will energize and the open message shown at right, will display on the CAT for approximately 2 seconds and then revert back to the title page.

OPEN

TITLE PAGE

The Title Page has two lines of up to sixteen characters per line, including punctuation. The Title Page can be programmed from the keypad in the same manner as names were programmed.

The CAT comes with a title page that says "PRESS # TO VIEW DIRECTORY", until the title page is reprogrammed. To program the Title Page from the factory default of "PRESS # TO VIEW DIRECTORY", press "9" from the System Parameters menu to get this sub-menu. Key in the desired characters. Press BkSpc to backspace one character. When the first line is complete, press "Enter" key to advance to the second line.

TITLE PAGE additional Line

Continue the second line as required. If you require any modifications of line 2, then line 1 must be re-entered first. After completion, press "Enter" key. This will return you to the System Parameters menu.

NOTE: REMEMBER TO PRESS <Enter> KEY AFTER LAST CHARACTER, OR IT WILL NOT BE PROGRAMMED.

COMMUNICATIONS SETUP

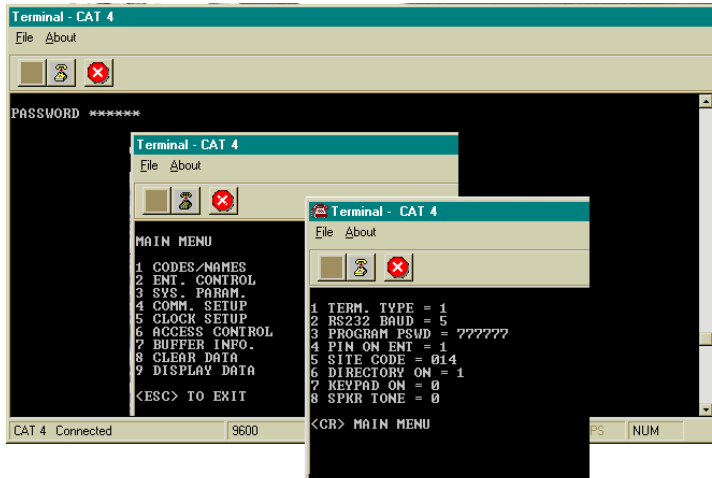

The Communications Setup menu comes with factory defaults that should be sufficient for most installations. These default values are shown on Pg. 51 and 52. Some functions are used with options that may not be present on your CAT. For example, selection 2 RS-232 Baud is not valid unless you purchase the optional serial printer interface (OPTKPRT). To get the right menu, press "4" from the main menu.

TERMINAL TYPE

The CAT is designed to respond to terminals that follow VT-100B terminal control codes. It also can respond to "dumb terminal" codes. To disable the Terminal Type from the factory default of 1, press "1" from the Communications Setup menu to get this sub-menu. Press "0" to disable VT-100B emulation, and press "Enter" key.

RS-232 BAUD

The RS-232 Baud refers to the rate of speed for serial communications, such as a printer or terminal would need. This function requires the optional printer interface (OPTKPRT). The different rates are:

- | | | | |
|--------------------------------------|-----|-------|------|
| | 0 = | 300 | BAUD |
| | 1 = | 600 | BAUD |
| | 2 = | 1200 | BAUD |
| Protocol for serial devices is fixed | 3 = | 2400 | BAUD |
| at 8 bits, No parity, 1 stop bit. | 4 = | 4800 | BAUD |
| (8,N,1) | 5 = | 9600 | BAUD |
| | 6 = | 19200 | BAUD |

To change the RS-232 Baud from the factory default of 5, press "2" from the Communications Setup menu to get this sub-menu. Next, select the number corresponding to the desired baud, and press "Enter" key. This will return you to the Communications Setup menu.

PROGRAM PASSWORD

The CAT leaves the factory with a default password of 777777. The Password may be alphanumeric (1 - 6 characters) if programmed from the terminal. From the front keypad, only numbers (1 - 6 digits) are supported. This provides an additional level of security if you connect a terminal to a CAT. It is possible to create passwords that can not be accessed from the front keypad. To change the Program Password from the factory default of 777777, press "3" from the Communications Setup menu to get this sub-menu. Key in the desired 6 digits for the new password, and press "Enter" key. You will be returned to the Communications Setup menu.

NOTE: 1st 2 DIGITS OF PROGRAM PASSWORD ARE THE CONTROL PASSWORD, FOR REMOTE CONTROL OF CAT UNIT (SUCH AS ENTRANCE LATCH). 1st 3 DIGITS OF PROGRAM PASSWORD ARE THE MANAGERS PASSWORD THAT ALLOWS ONLY CODE, NAME, PHONE, PIN, CARD, AND GROUP CHANGES.

PIN ON ENTRANCE

This function determines which door control relay is activated when a PIN code (or a Rotary "6" from a called unit) is received by the CAT. To change the number from the default setting of 1 to another number, select "4" from the main menu. Select "4" from this sub-menu. Select the new number (from 1 — 4) and press the "Enter" key. You will be returned to the COMM. SETUP menu.

The Site Code (sometimes called a Facility Code) is used with the Card Readers. Site Code is used to identify the group of cards being used with a particular CAT. This keeps cards on one facility from being used in another facility. The range of Site Codes is from 000 - 255. To change the Site Code from the factory default of 000, press "5" from the Communications Setup menu to get to this sub-menu. Key in the desired 3 digits corresponding to the Site Code of the cards you have purchased, and press "Enter" key.

NOTE: IF SITE CODE = "000" THE CARD READER FUNCTION IS DISABLED, AND CARD # WILL NOT APPEAR IN CODE/NAMES PROGRAMMING MENU . IF SITE CODE IS SET TO 255, THE SITE CODE ON THE CARD WILL BE IGNORED, AND SECURITY OF CARDS WILL BE REDUCED.

DIRECTORY ON / OFF

This selection allows all directory names to be suppressed from the display. The codes keyed in will still display. All names will still print to the optional printer (OPTKPRT). To disable Directory from the factory default of 1, press "6" from the Communications Setup menu to get this sub-menu. Press "0" to disable Directory, and press "Enter" key.

KEYPAD ON / OFF

This selection allows the keypad to remain active after dial out. This is useful for answering machines, voice mail, and other functions requiring a Touch-Tone™ signal after communications are established. To enable keypad from the factory default of 0, press "7" from the Communications Setup menu to get this sub-menu. Press "1" to enable the keypad, and press "Enter" key. Only the number keys are active, * and # will not work. Press "Enter" key. This will return you to the System Parameters menu.

SPEAKER TONE

This selection allows the speaker to be activated for remote control from a telephone in order to listen in. When enabled, the CAT has an open audio channel to permit conversation from someone calling in to the CAT (the microphone is also enabled at the same time). To enable speaker from the factory default of 0 (disabled), press "8" from the Communications Setup menu to get this sub-menu. Select a digit from 1 to 9 to enable speaker, and press "Enter" key. This will return you to the Communications Setup menu.

UPDATE LCD (CATVISION ONLY)

This selection allows information in the CAT memory to be transferred to the display memory. Press 9 to enable update and then press "Enter" key. This will return you to the Communications Setup Menu.

CLOCK SETUP

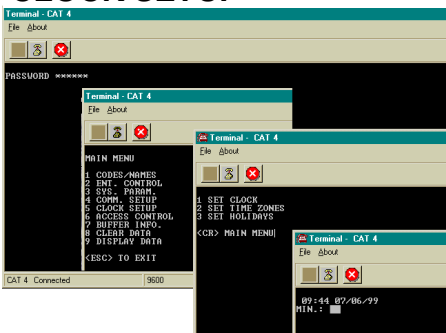

SETTING TIME / DATE

MIN.: Select "1" to set the time & date. You will be prompted to enter the current time in minutes as a one or two digit number (0 to 59). If you make a mistake, press <BkSp> to backspace one character. After the minutes are entered, press the "Enter" key.

HOUR: Enter a 1 or 2 digit number (0 to 23) to set the hour. If a mistake is made, press <BkSp> to backspace each character. After the hour is entered, press the "Enter" key.

DAY, 1..7: This is NOT the day of the month. This is a number which corresponds to the day of the week. Enter a number corresponding to the day of the week. Sunday is "1", Saturday is "7" and so forth. If you make a mistake, press <BkSp> to backspace one character. After the day of the week is entered, press the "Enter" key.

NOTE: ONCE TIME/DATE PROGRAMMING HAS BEGUN, ALL SELECTIONS MUST BE COMPLETED FOR CHANGES TO TAKE EFFECT.

DATE: Enter a 1 or 2 digit number to set the day of the month. If a mistake is made, <BkSp> to backspace one character. After the day is entered, press the "Enter" key.

MONTH: Enter a 1 or 2 digit number to set the month. If you make a mistake, <BkSp> to backspace one character. After the month is entered, press the "Enter" key.

YEAR: Enter a 2 digit number to set the year. If you make a mistake, <BkSp> to backspace one character. After the year is entered, press the "Enter" key. You will be returned to the Clock Setup menu.

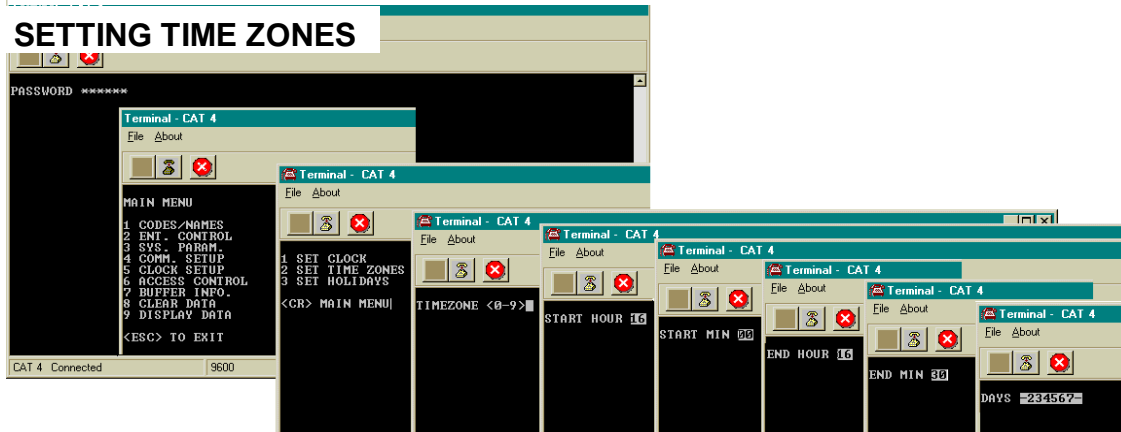

A time zone is a period of time that limits when the CAT is valid. Use this to control access to a facility, when a given condition is valid, based on:

- 1) The time of day.
- 2) The day of the week.
- 3) Whether or not the day of the week is a Holiday.

A time zone is valid only within a 24 hour period that begins at midnight. A time zone has a start time and an ending time. This can be as short as two minutes, or as long as 24 hours. This time period is valid in combinations from 1 to 7 days and Holidays. There are 16 time zones numbered 0 - 15 available for use on a CAT. Not all time zones can be reached from this menu. To access all of them you must use Selcom 7 or newer. Holidays may be set up at any time. A time zone can have valid Holidays, or invalid Holidays. A time zone can be set that is only valid on Holidays, for applications that require different hours of access on Holidays.

From the main menu, select "5" for clock setup, then "2" for time zone.

TIMEZONE <0-9>: You will be prompted to select a time zone between 0 and 9. If you make a mistake, press BkSp to backspace one character. Once programming of a time zone is begun, all choices must be keyed in or you will be returned to the beginning of the time zone menu.

START HOUR 00: After the time zone is selected, press the "Enter" key. You will be prompted to key in the hour. This is a 1 or 2 digit number. The hour is expressed in 24 hour format (e.g., 2:25 P.M. is keyed in as 14:25), from 00:00 to 23:59.

If you make a mistake, press <BkSp> to backspace one character. After the hour is entered, press the "Enter" key.

START MIN 00: You will be prompted to key in the minute. This is a 1 or 2 digit number between 00 and 59. If you make a mistake, press <BkSp> to backspace one character. After the minute is entered, press the "Enter" key.

STOP HOUR 00: . You will be prompted to key in the stop hour. This is a 1 or 2 digit number. The hour is expressed in 24 hour format (e.g., 2:25 P.M. is keyed in as 14:25), from 00:00 to 23:59.

If you make a mistake, press <BkSp> to backspace one character. After the hour is entered, press the "Enter" key.

STOP MIN 00: You will be prompted to key in the stop minute. This is a 1 or 2 digit number between 00 and 59. If you make a mistake, press <BkSp> to backspace one character. After the minute is entered, press the "Enter" key.

SETTING HOLIDAYS

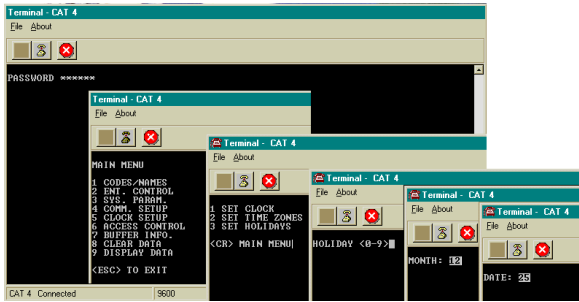

Holidays can be used to keep time zones valid (or not) on Holidays, or by setting a different time zone to be valid for a different period of time on a Holiday. There are 16 Holidays numbered 0 - 15 available for use on a CAT. Not all holidays can be reached from this menu. Use Selcom 7 or newer to set all the holidays.

HOLIDAY <0-9>: Select "3" to set the Holiday. Holidays may be entered in any order. You will be prompted to select a Holiday between 0 and 9. If you make a mistake, press <BkSpc> to backspace one character.

MONTH: After the Holiday is selected, you will be prompted to key in the month. This is a 1 or 2 digit number. If you make a mistake, press <BkSpc> to backspace one character. Press the "Enter" key after the month is entered.

DATE: After the month is selected, you will be prompted to key in the date. This is a 1 or 2 digit number between 1 and 31. If you make a mistake, press <BkSpc> to backspace one character. Press the "Enter" key after the date is entered.

This table may be used to help keep track of which Holidays are required for this installation. Writing them down in the table provided will help reduce programming entry errors. Remember, Holidays may be entered in any order.

Holiday	Month	Day	Holiday
0			
1			
2			
3			
4			
5			
6			
7			
8			
9			
10			
11			
12			
13			
14			
15			

ACCESS CONTROL

Access Control from a CAT is based on four general sets of conditions:

- 1) When a resident (who has been called from a CAT) keys in a valid door tone.
- 2) When a valid PIN code is presented at a door that is valid:
 - a) based on the time of day.
 - b) based on the day of week.
 - c) based on whether the day of the week is a Holiday or not.
- 3) When a valid card number is presented at a door card reader which is valid:
 - a) based on the card reader next to the entrance chosen for access.
 - b) based on the time of day.
 - c) based on the day of week.
 - d) based on whether the day of the week is a Holiday or not.
- 4) When an entrance group is valid, using automatic un-lock and re-lock.

The CAT has many combinations of access control based on these criteria. This versatility can be confusing, unless the access has been carefully defined BEFORE programming begins. The order in which to plan for an installation should be as follows:

1. Define access area. One entrance, or up to 16?
2. Define time zones.
 - What times is access allowed?
 - For Whom is access allowed? Everybody, or different groups of people?
 - What days is access to be allowed?
 - Are the time zones the same for different days, or different for different days?
 - Are Holidays used, and do Holidays require different time zones?
3. Define Access levels.
 - What time zone is valid for a given access level?
 - Which door is valid for an access level?
 - Is more than one door valid for a time zone?
4. Define Access Groups.
 - What combinations of access levels are in a group?
 - Is the access group to be used for PIN codes and Cards?
 - Is the access group to be used for automatic un-lock and re-lock?

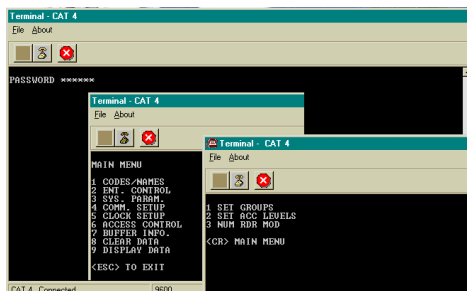

The menu choices in this manual follow the order in which they appear on a CAT. These choices are in reverse order from how a site installation is typically planned. There are tables associated with each section. They are there to help with site planning. It is strongly recommended they be completely filled out BEFORE attempting any programming.

From the main menu select "6" for Access Control.

ACCESS GROUPS

Access Groups are used to allow groups of individuals card or PIN access by assigning a level or combination of levels to their group. Access Group Zero is predefined as an unlimited group. Group Zero allows access 24 hours a day, ALL days of the year. Access Groups are assigned to the individuals in the Directory. If you do not assign a Group to an individual during the directory entry, Zero (0) is assigned by default.

Since Access Levels can have different Time Zone and entrance combinations, this creates many combinations for control of an entrance based on PIN, Card, or time of day.

The second application for Access Groups is for automatic Unlocking (Opening) and Relocking (Closing) Entrances. If an Access Group has no valid Access Levels assigned, it may be used to prevent any entrance access at all.

SELECTING AN ACCESS GROUP

Select "6" from the main menu. Press the "Enter" from a terminal. Select "1" from this sub-menu. You will be prompted to select a group from 1 - 9 as shown below. Press the "Enter" key. Not all

Groups can be reached from this menu. Use Selcom 7 or newer to set or use all the Groups.

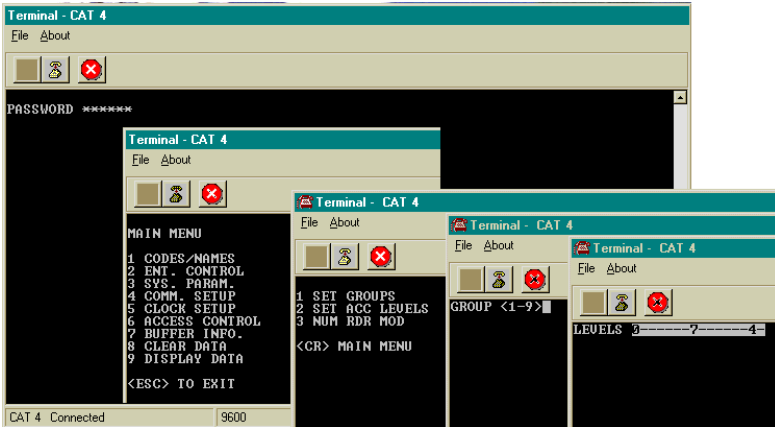

SELECTING ACCESS LEVELS IN A GROUP

After selecting a group, you will be prompted for levels. These are any combinations from 0 - 15 in any order. To change access levels for a given group, Not all levels can be programmed from this menu. Use Selcom 7 or newer to set all levels.

Select "6" from the main menu. Press the "Enter" key.

Select "2" from this sub-menu. You will be prompted to select levels from 0 - 9 as shown above. Key in the new levels desired and press the "Enter" key. To delete access levels entirely use Clear Access Levels. Not all Levels can be reached from this menu. Use Selcom 7 or newer to set or use all the levels in the Groups

ACCESS LEVELS

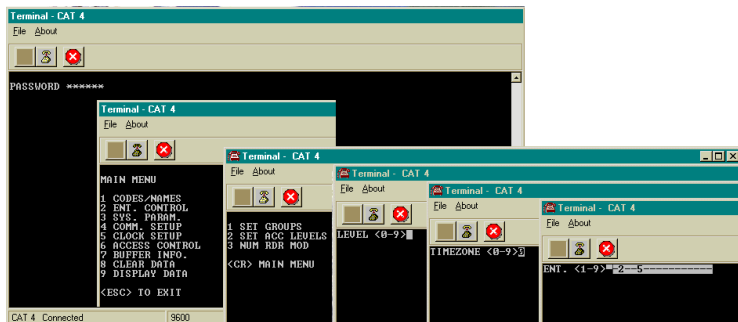

Access Levels are used to attach Time Zones to specific Entrances. Only one Time Zone is allowed per Access Level. Any combination of entrances may be selected, but at least one entrance must be selected, or the affected Access Level will not function. From one to sixteen entrances may be assigned to an Access Level. Different combinations of control may be created. Do this by assigning one entrance a Time Zone

and an Access level, and another entrance the same Time Zone but a different Access Level. Now these Access Levels can be grouped in different combinations for the Access Groups.

SELECTING A TIME ZONE

You will be prompted to select a time zone from 0 - 9 as shown at left. Select the desired zone number and press the "Enter" key. Not all time zones can be reached from this menu. Use Selcom 7 or newer to set all the time zones.

SELECTING A ENTRANCE

You will be prompted to select a door 1 - 9 as shown at left. Select the desired door combination and press the "Enter" key. Your system may not have all of the entrances. Not all entrances can be reached from this menu. Use Selcom 7 or newer to set or use all the entrances.

Use the table across to help keep track of which Access Levels are required for this installation. Writing them down in the table provided will help reduce programming entry errors.

ACCESS LEVELS continued

ACCESS	TIME																
0																	
1																	
2																	
3																	
4																	
5																	
6																	
7																	
8																	
9																	
10																	
11																	
12																	
13																	
14																	
15																	

AUTOMATIC UNLOCK AND RELOCK BY TIME ZONE

The following example shows how a business might keep two entrances open during peak employee traffic, and secure those two entrances at all other times. Time Zone 1 is valid for one half hour in the morning, Monday through Friday. Time Zone 2 is valid for one half hour in the afternoon, Monday through Friday. Time Zone 0 is valid all the time, except Holidays.

Each Time Zone is assigned to a different Access Level. Both entrances are selected in the Access Levels. The morning and the afternoon Access Levels are grouped together in Access Group 1.

By setting Entrance Group 1 to Access Group 1, the entrance will automatically unlock during peak traffic, and relock at all other times. Employees whose PIN codes or cards are set to Access Level 0, can open the entrance at all other times. If employees try to use their PIN code while the entrances are unlocked, the display on the CAT will show "OPEN".

Time Zone Setting

Time Zone	Start Time		Stop Time		Day of the Wk								
	Hours HH	Min. MM	Hours HH	Min. MM	SU	MO	TU	WE	TR	FR	SA	Hol	
0													
1	07	45	08	15		X	X	X	X	X			
2	16	45	17	15		X	X	X	X	X			

Access Level Setting

- AL1 (USES TIME ZONE 1 MORNING HOURS M - F) , Entrances 1 & 2
- AL2 (USES TIME ZONE 2 AFTERNOON HOURS M - F), Entrances 1 & 2

ENTRANCE

ACCESS LEVEL	TIME ZONE	1	2	3	4	5	6
0							
1	1	X	X				
2	2	X	X				

EXAMPLE OF AN AUTOMATIC UNLOCK APPLICATION . . .Continued. . .

AG1 (USES ACCESS LEVELS 1 AND 2)

THEN USE AG1 TO AUTO UNLOCK ENTR. 1 AND ENTR. 2

Access Levels					
ACCESS					
0	Always Active	Always Active			
1	X	X			
2					

These are shorter versions of the other tables in this manual. Start by defining which entrance is to be unlocked, for how long, on which days. This is the time zone data. Next, define which combinations of doors are controlled by a time zone. This is an access level. Last, group access levels into an access group. The Entrance Group is that access group number.

TRANSACTION BUFFER INFORMATION

The transaction buffer stores any event that would normally create a logging printer message. For examples of report messages, see below. The size of the transaction buffer depends on the capacity of the CAT. Usually, the smaller the capacity the larger the transaction buffer space. After a transaction buffer becomes full, it begins to overwrite the oldest event in the transaction buffer storage space.

VIEW LOG

Press "7" then "1" from the main menu to get the selections shown below. View Log will display the Log one page at a time. Press "0" to stop and then "Enter" key to return to the Main menu

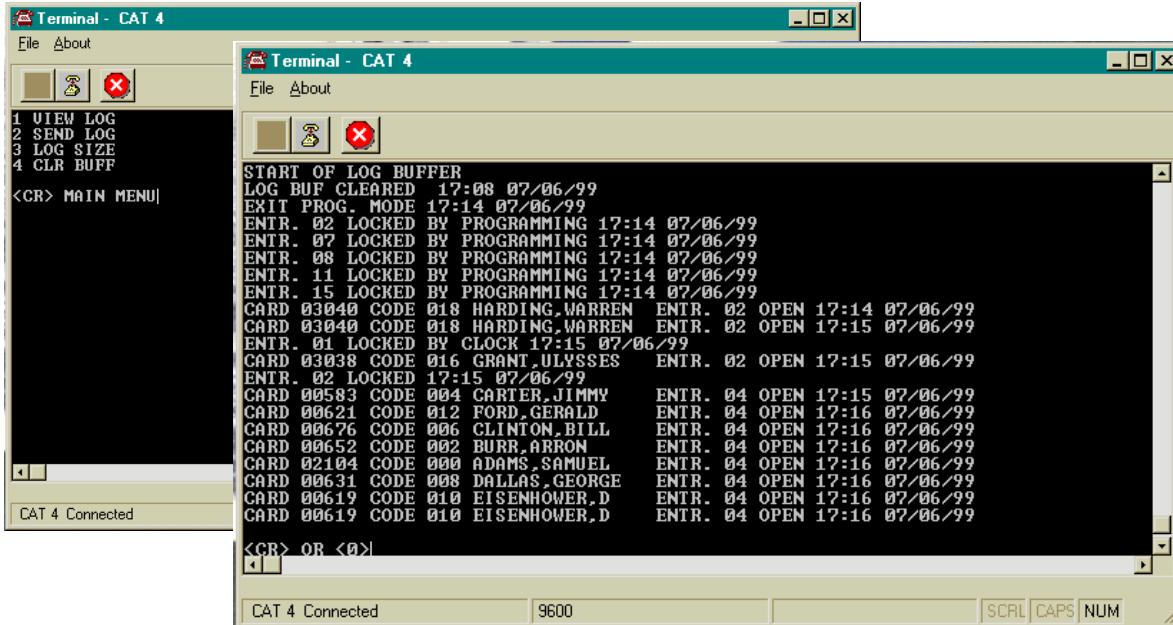

SEND LOG

Pressing "2" will send all logging data. This allows the log to be viewed from start to finish from the terminal. The log will be shown non-stop . **CAUTION:** No entry is accepted until the complete log is sent.

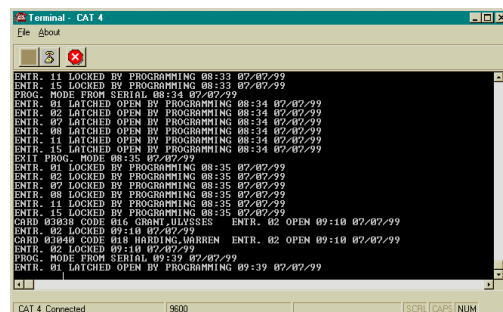

TRANSACTION BUFFER FREE

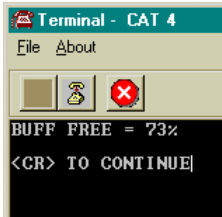

Pressing "3" will only show the approximate amount of space remaining in the buffer. A message similar to left will appear.

CLR (Erase) BUFFER

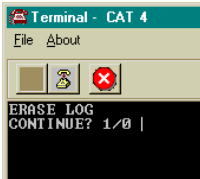

CLR BUFFER: Press "4" to get to the selection at left. Pressing a "1" then "Enter" key clears all transactions stored in the buffer for the CAT. If you press a "1" by mistake, press BkSpC to backspace over the "1". Press "0" then "Enter" key to return to the main menu. If you press any key other than "1", the CAT will sound a long error beep. Press "Enter" key to return to the Buffer Information menu. Press "Enter" key again, to return to the Main menu.

CLEAR DATA

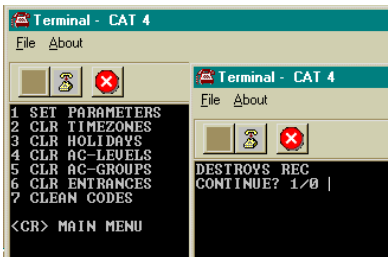

The Clear Data selections enable you to reset the unit to zero values or factory defaults if zero would not be acceptable. A warning message requiring you to press "1" is present for each action. Press "Enter" key to return to the Main menu.

SET PARAMETERS

Pressing "1" returns all Entrance Control, System Parameters and Communication Setup settings to the SES factory defaults. These defaults are shown on Pg. 51 and 52. Press "1" to reset the parameters. Press "Enter" key to return to the Main menu.

CLEAR TIME ZONES

Pressing "2" causes this selection to clear any previously programmed time zone and resets all times to 00:00. Press "1" to reset the parameters. Press "Enter" key to return to the Main menu.

CLEAR HOLIDAYS

Pressing "3" causes this selection to clear all Holidays from memory. This is useful for Holidays that are observed on different days from year to year, such as Thanksgiving or Labor Day. Press "1" to reset the parameters. Press "Enter" key to return to the Main menu.

CLEAR ACCESS LEVELS

Pressing "4" causes this selection to clear all access levels of any previously programmed data. Press "1" to reset the parameters. Press "Enter" key to return to the Main menu.

CLEAR ACCESS GROUPS

Pressing "5" causes this selection to clear all access groups of any previously programmed data. Press "1" to reset the parameters. Press "Enter" key to return to the Main menu.

CLEAR ENTRANCES

Pressing "6" causes this selection to clear all entrance data. Press "1" to reset the parameters. Press "Enter" key to return to the Main menu.

CLEAN CODES

Pressing "7" causes this selection to clean all corrupted directory data. Press "1" to reset the parameters. Press "Enter" key to return to the Main menu.

DISPLAY DATA

Pressing the menu election "9" is used with a terminal for sub-menu choices 1 through 5. Data is sent to the screen. It is used to print various parameters, such as Time Zones, Holidays, Access Levels, Access Groups and general Information. Sub-menu choices 6 through 9 send data to the LCD display on the front panel of the CAT. To select this function, press "9" from the Main Menu. You will see the displays, shown below

The image displays seven overlapping terminal window screenshots, each showing a different menu option and its associated data. The windows are titled 'Terminal - CAT 4' and 'Menu 1' through 'Menu 7'. Each window shows a list of menu items and their corresponding data values.

Menu 1: Shows system parameters such as USER 4.11 4R, CODE CAP = 0500, PHONE CAP = 0500, CODE LENGTH = 3, PIN LENGTH = 4, SITE CODE = 000, CR BIT TYPE = 0, NUM RDR MOD = 0, DISP TYPE = 2, ENA ACC GRP = 0, PRESS # TO VIEW DIRECTORY, and PROGRAM PSWD = ????????.

Menu 2: Displays a table of ZONE, STIME, ETIME, and SMTWFSH values for zones 00 through 15.

Menu 3: Shows a table of HOL, MONTH, and DATE values for months 00 through 16.

Menu 4: Displays a table of LEU, ENTRANCE, TZ, STIME, ETIME, and SMTWFSH values for entrances 00 through 15.

Menu 5: Shows a table of AG, AL, ENTRANCE, TZ, STIME, ETIME, and SMTWFSH values for access groups 01 and 13.

Menu 6: Displays a table of ENT NO., OPEN TIME, OPEN TONE, OPEN GROUP, AUTO, LATCH TONE, AJAR TIME, SPEC RLY, and OPEN PROG values for entries 01 through 16.

Menu 7: Shows a table of ENT NO., AUTO GROUP, ACCESS LEU, TZ, START TIME, END TIME, and WEEK DAYS values for entries 01 through 14.

CAT Series v 4.1X

FCC REQUIREMENTS

The Federal Communications Commission (FCC) has established Rules which permits this device to be directly connected to the telephone network. Standardized jacks are used for these connections. This equipment should not be used on party lines or coin lines.

If this unit is malfunctioning, it may also be causing harm to the telephone network. This device should be disconnected until the source of the problem can be determined and until repair is made. If this is not done, the telephone company may temporarily disconnect service.

The telephone company may make changes in its technical operations and procedures. If such changes affect the compatibility or use of this device, the telephone company is required to give adequate notice of the changes. You will be advised of your right to a complaint with the FCC.

If the telephone company requests information on what equipment is connected to their lines, inform them of:

- a. The telephone number this unit is connected to
- b. The ringer equivalence number
- c. The USOC jack required
- d. The FCC Registration number

Items 'b' and 'd' are indicated on the label.

The ringer equivalence (REN) is used to determine how many devices can be connected to your telephone line. In most areas, the sum of the RENs of all devices should not exceed five (5.0). If too many devices are attached, they may not ring properly.

NOTICE: The Canadian Department of Communications label identifies certified equipment. This certification means that the equipment meets certain telecommunications network protective, operational and safety requirements. The Department does not guarantee the equipment will operate to the user's satisfaction.

Before installing this equipment, users should ensure that it is permissible to be connected to the facilities of the local telecommunications company. The equipment must also be installed using an acceptable method of connection. In some cases, the company's inside wiring associated with a single line individual service may be extended by means of a certified connector assembly (telephone extension cord). The customer should be aware that compliance with the above conditions may not prevent degradation of service in some areas.

Repairs to certified equipment should be made by an authorized Canadian maintenance facility designated by the supplier. Any repairs or alterations made by the user to this equipment, or equipment malfunctions, may give the telecommunications company cause to request the user to disconnect the equipment.

Users should ensure for their own protection that the electrical ground connections of the power utility, telephone lines and internal metallic water pipe system, if present, are connected together. This precaution may be particularly important in rural areas.

Caution: Users should not attempt to make such connections themselves, but should contact the appropriate inspection authority, or electrician, as appropriate.

The **Load Number** (LN) is assigned to each terminal device. This denotes the percentage of the total load to be connected to a telephone loop which is used by the device, to prevent overloading. The termination on a loop may consist of any combination of devices. This is subject only to the requirement that the total Load Numbers of all devices does not exceed 100.

This digital apparatus does not exceed the Class A limits for radio noise emissions from digital apparatus. This is set out in the Radio Interference Regulations of the Canadian Department of Communications.

Le present appareil numerique n'emet pas de bruits radioelectriques depassant les limites applicables aux appareils numeriques de la Class A prescrites dans le Reglement sur le brouillage radioelectrique edicte par le ministere des Communications du Canada.

CAT Series v 4.1X

SERVICE REQUIREMENTS

In the event of equipment malfunction, all repairs should be performed by our Company or an authorized agent. It is the responsibility of users requiring service to report the need for service to our Company or to one of our authorized agents. Service can be obtained at:

Phone:

Warning: Changes or modifications not expressly approved by the party responsible for compliance could void the user's authority to operate the equipment.

NOTE: This Equipment has been tested and found to comply with the limits for a Class A digital device. This is pursuant to Part 15 of the FCC Rules. These limits are designed to provide reasonable protection against harmful interference when the equipment is operated in a commercial environment. This equipment generates, uses and can radiate radio frequency energy. If not installed and used in accordance with the instruction manual, may cause harmful interference to radio communications. Operation of this equipment in a residence is likely to cause harmful interference. If this is the case, the user will be required to correct the interference at his own expense.

“BETTER TECHNOLOGY MAKES BETTER SYSTEMS”

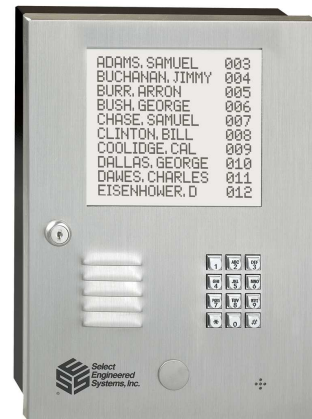
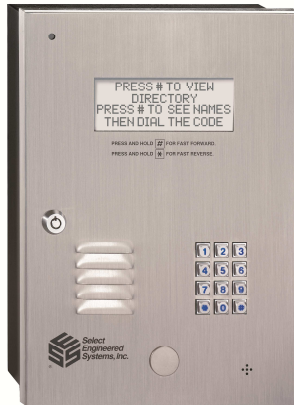
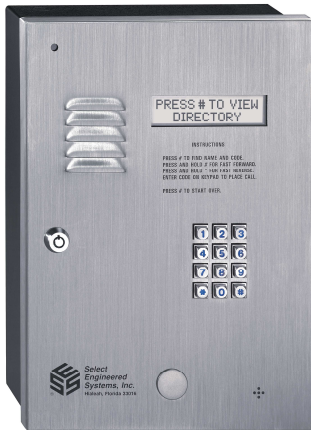

09/14



**Select
Engineered
Systems, Inc.**
7991 West 26th Ave.
Hialeah, FL 33016
Toll Free: 1-800-342-5737
In FL: 305-823-5410
Fax: 305-823-5215
website www.selectses.com
e-mail sales@selectses.com